

Playground

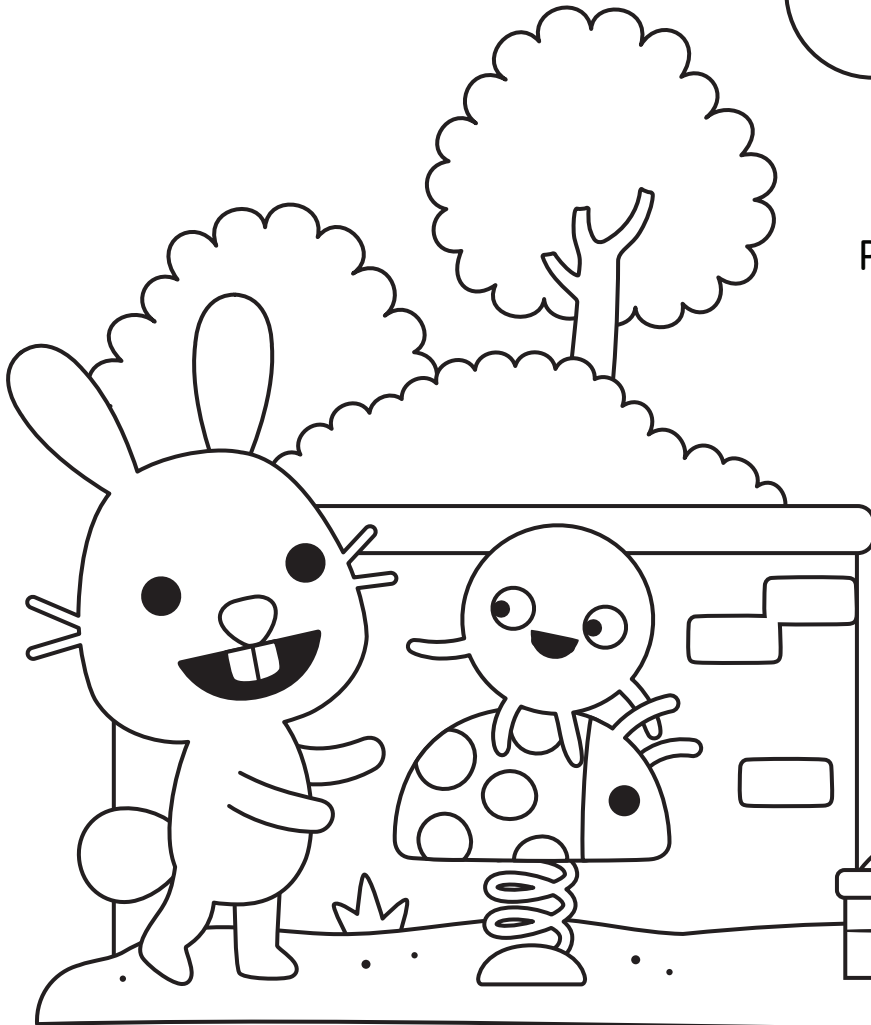

Supplies you'll need



crayons scissors glue pencil

Did you know?

Playgrounds have been around since 1885!

Why did the chicken cross the playground?

To get to the other slide!

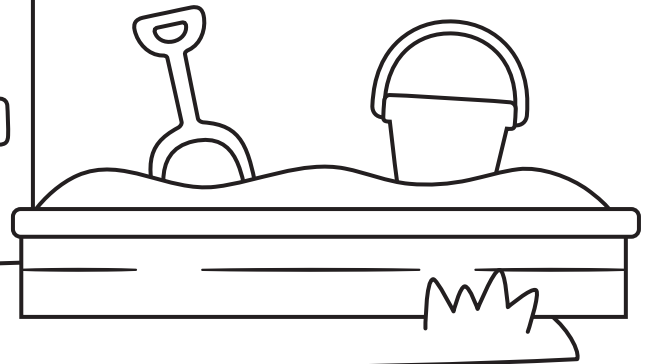

Activities included in this set



Create, cut, and solve a puzzle



Search for playground items in a scavenger hunt



Trace shapes that are found on a playground



Count the objects in a playground scene



Instructions:
Color and cut out the puzzle pieces, mix them up then put the picture back together!

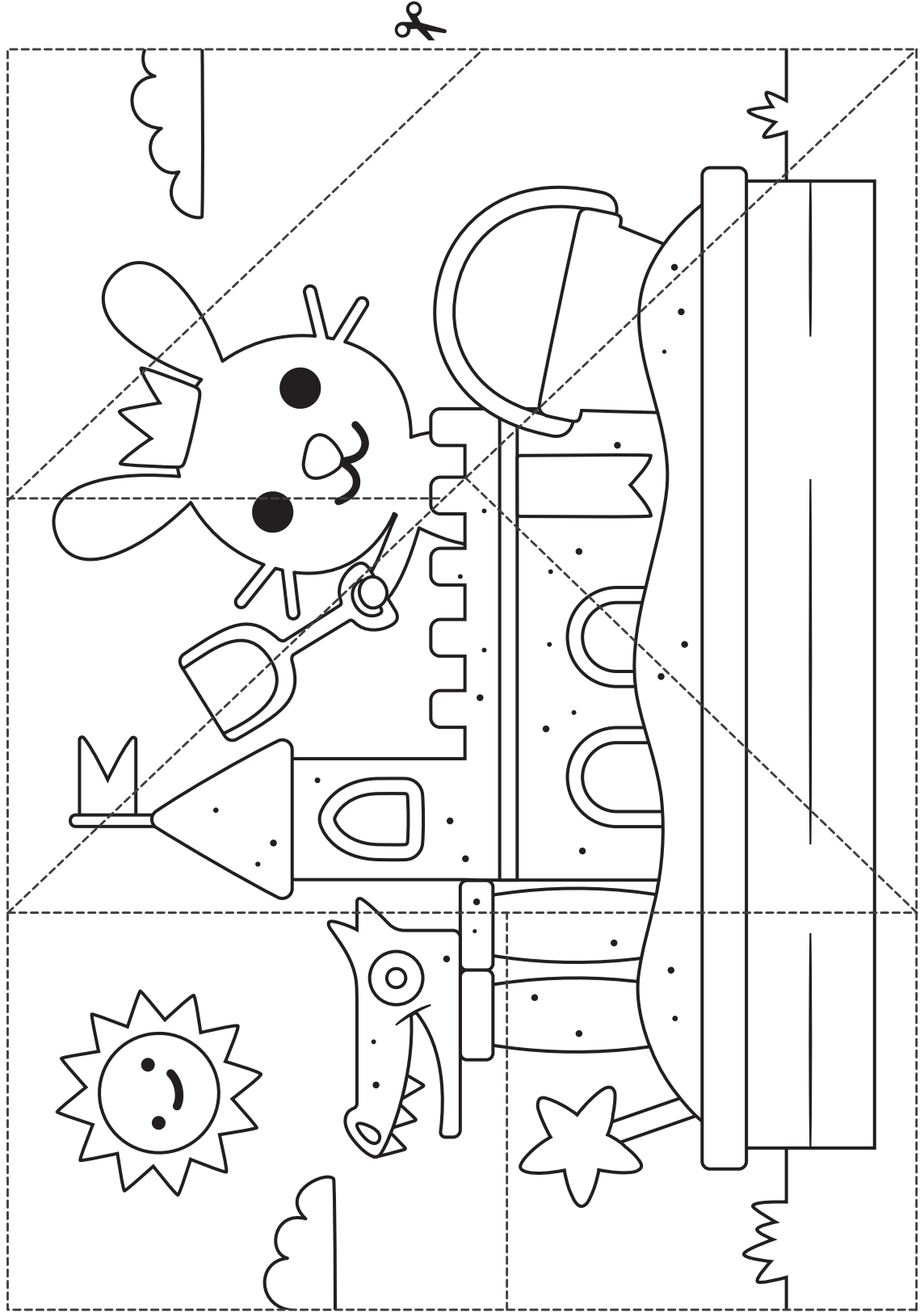
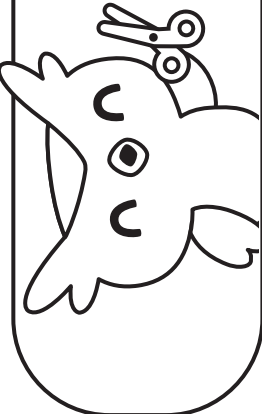



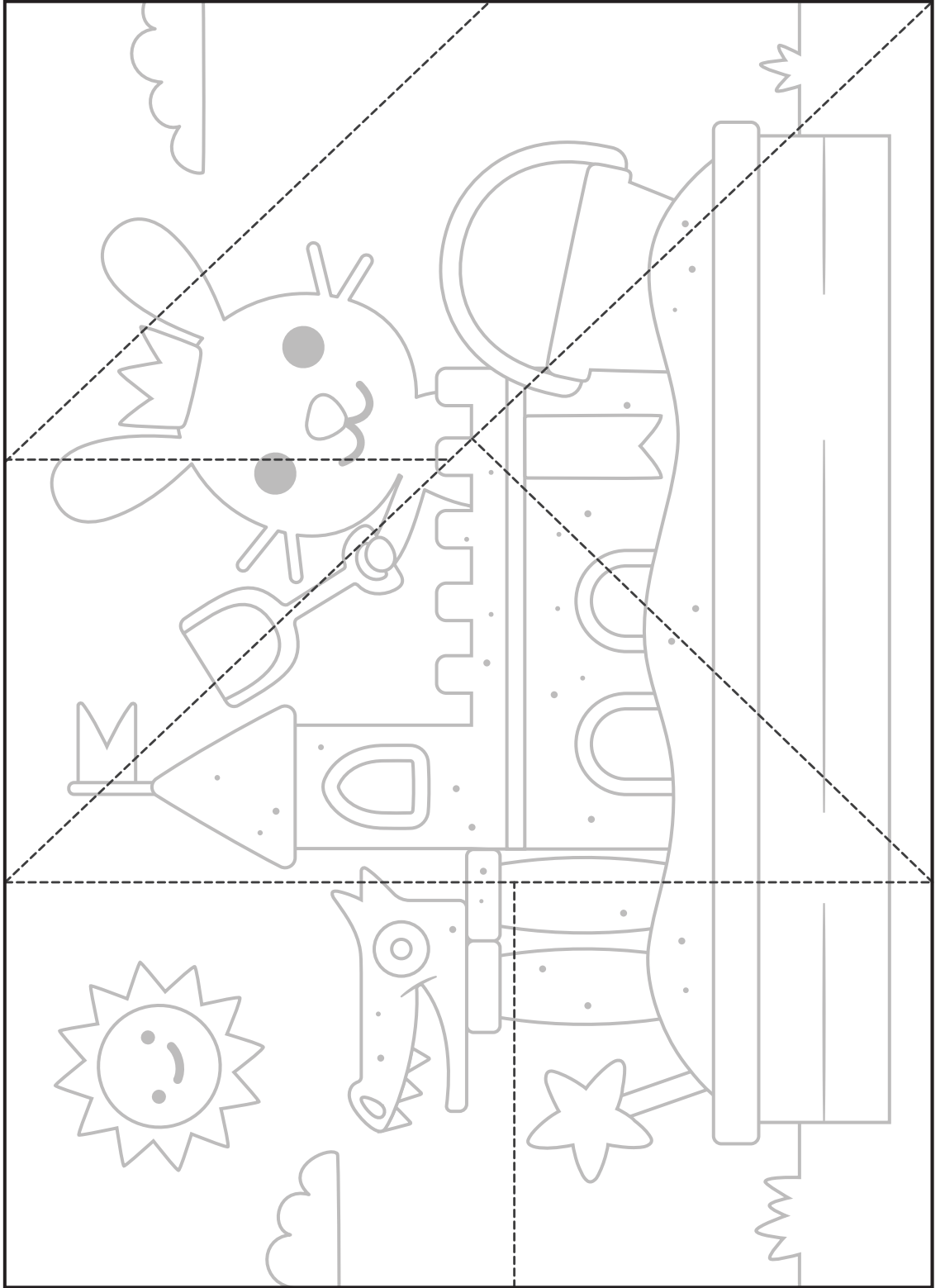

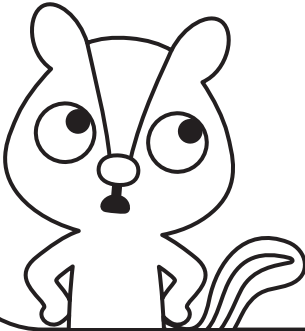











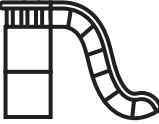



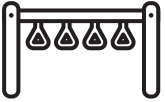





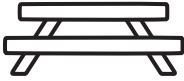





SAGO
mini



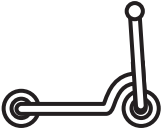

Instructions:
 Try to find these items at your local playground. Color in the smiley face for each item you find, and write the total at the bottom. Next week, try a new playground!



  LADDER	  BRIDGE	  SLIDE	  TUNNEL
  MONKEY BARS	  LEAF	  BALL	  PICNIC TABLE
  BICYCLE	  SANDBOX	  BENCH	  SWING
  SCOOTER	  SEESAW	  PINE CONE	  TREE

Total: _____

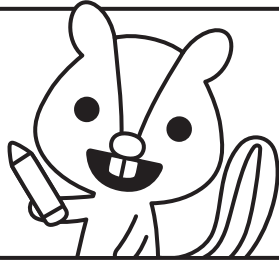

Instructions:
Trace the shapes to complete
the playground items.



triangle

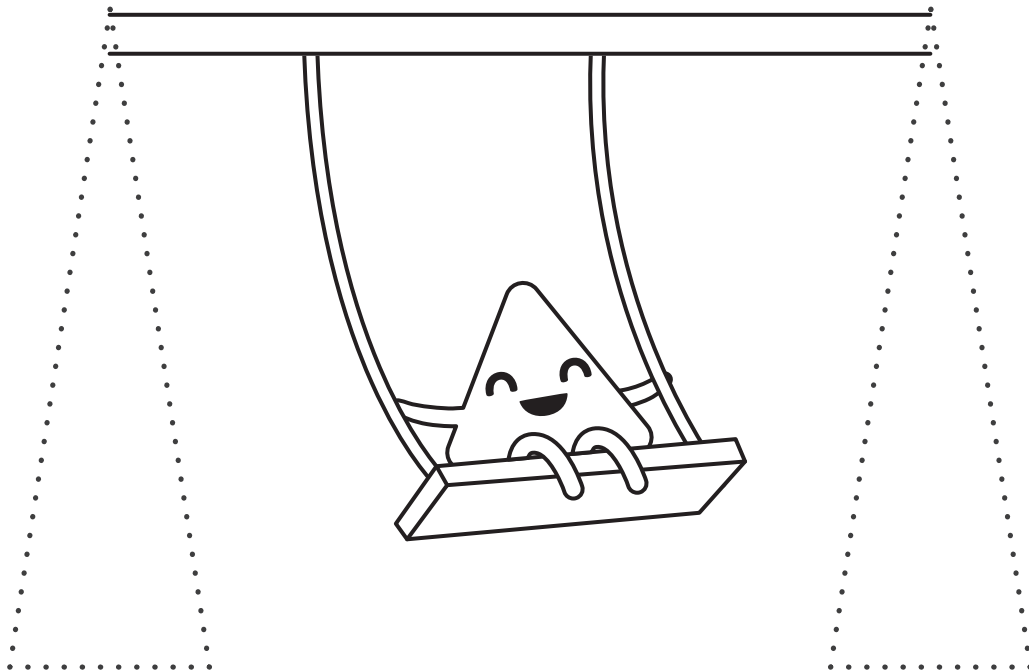
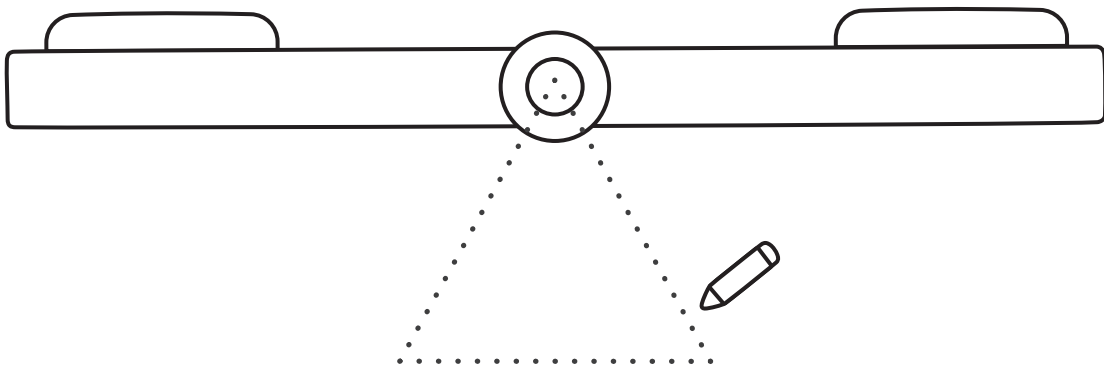

square

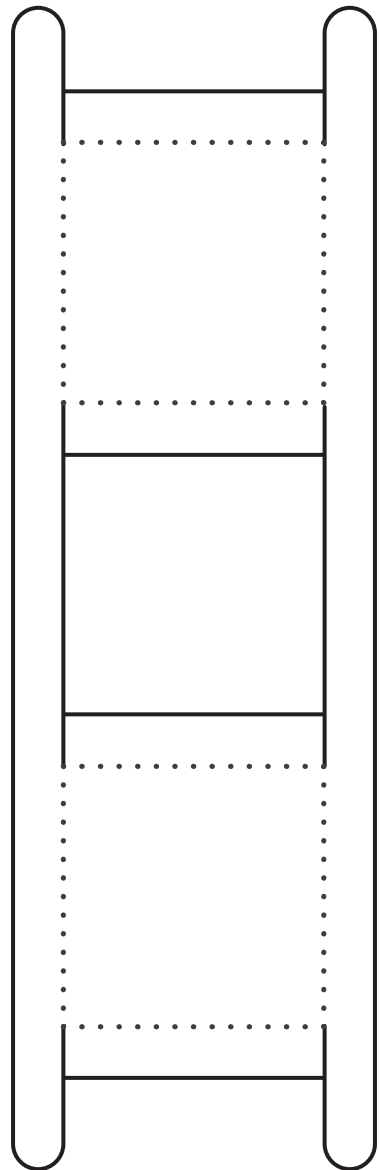
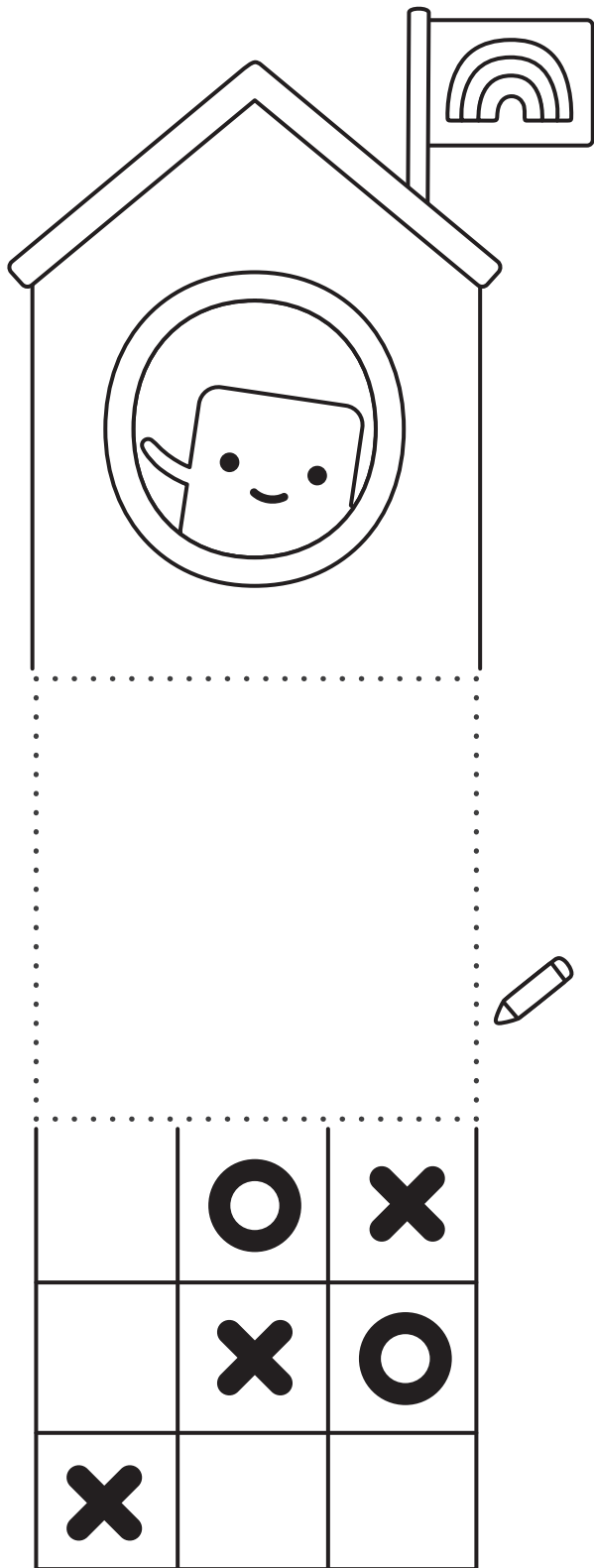

rectangle

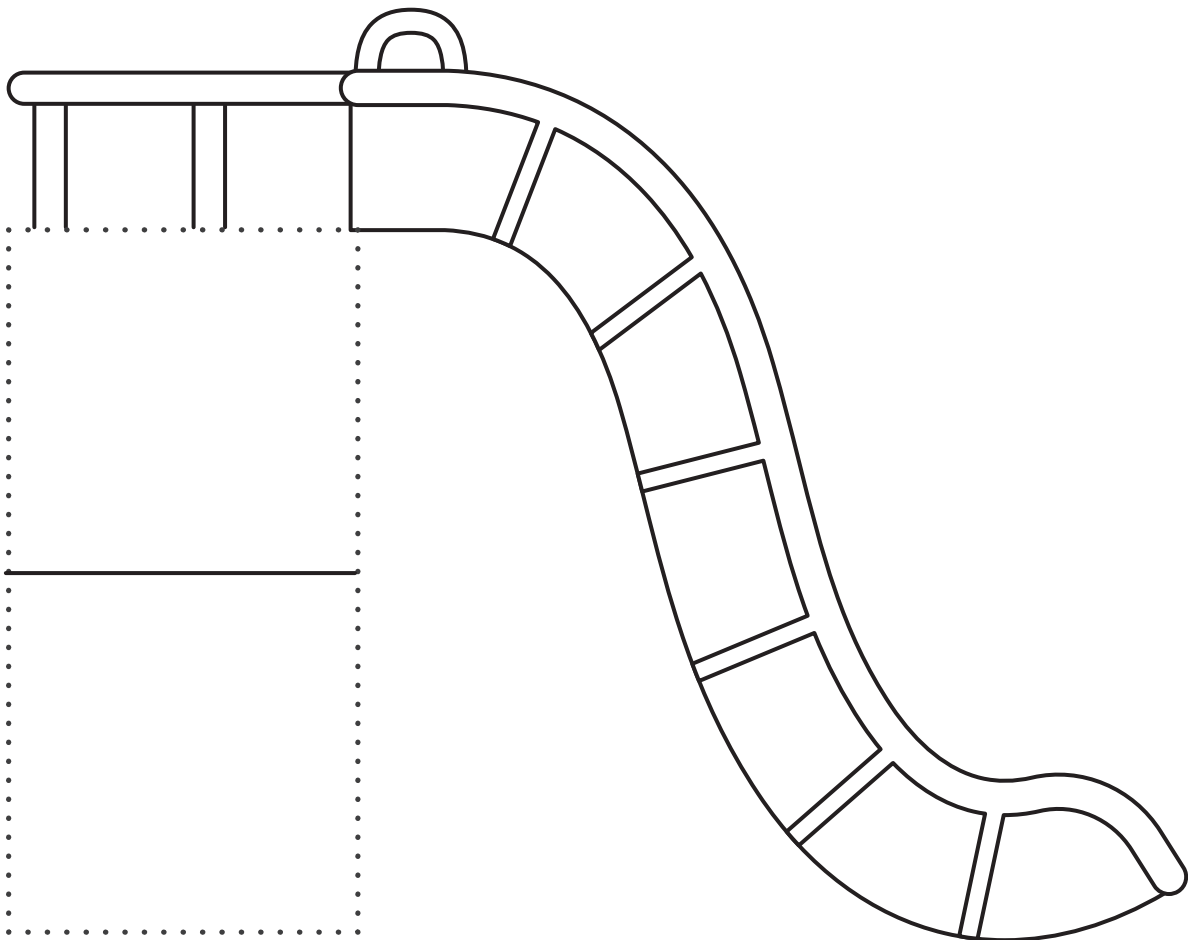
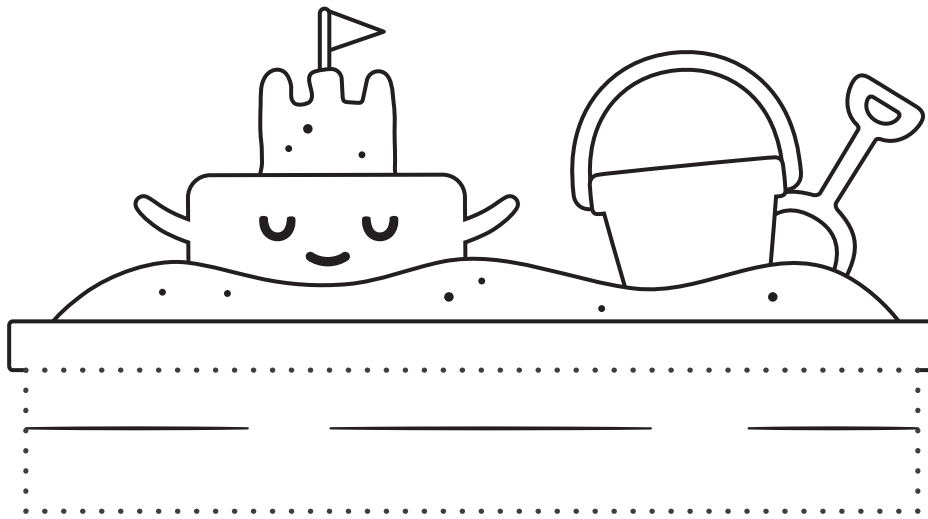

circle

