

The Jack Pack

Jack is a brainy bunny whose curiosity and endless creativity makes life interesting for everyone around him with his wild home-made inventions.

Supplies you'll need



crayons



scissors



glue



tissue box



toilet paper tube

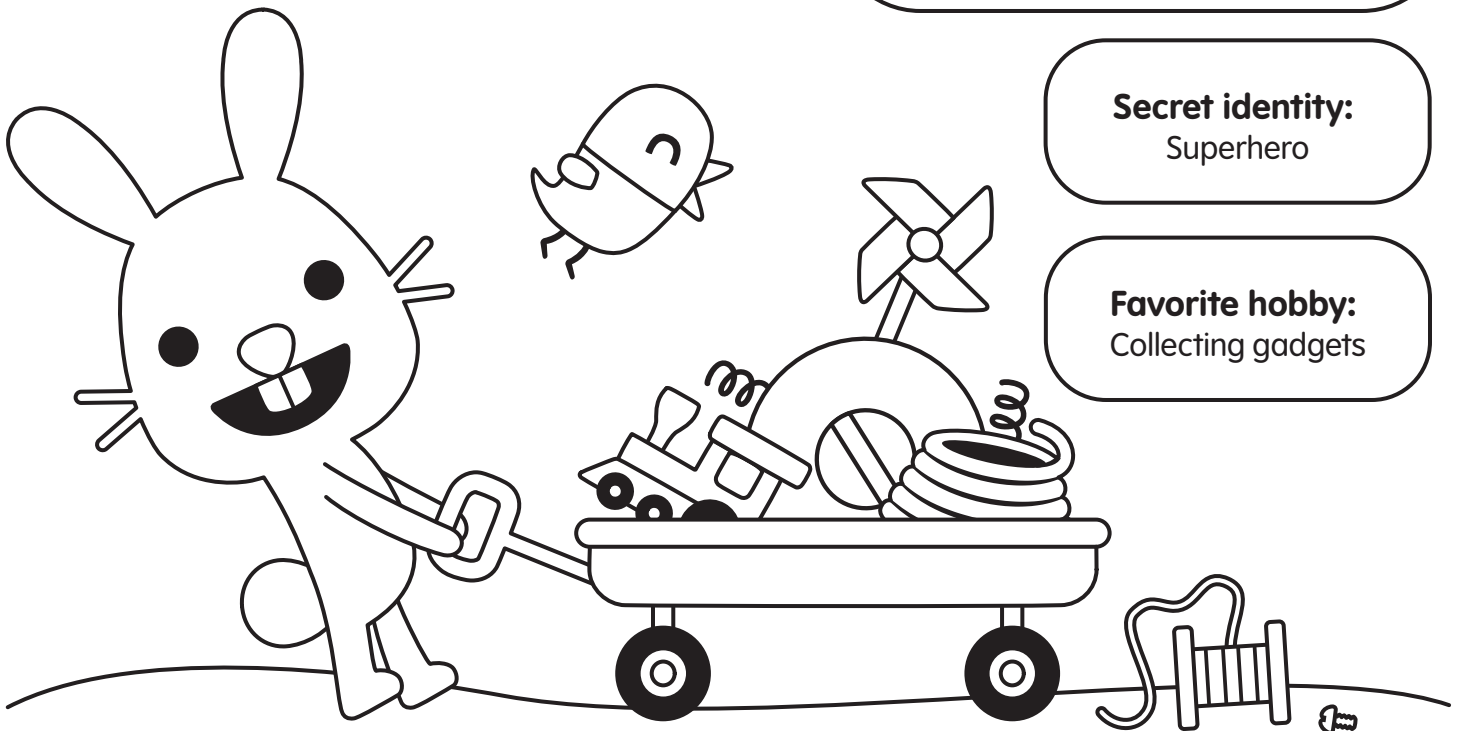

Secret identity:
Superhero

Favorite hobby:
Collecting gadgets

Activities included in this set



Super Jack
finger puppet



Tissue box
rocket car

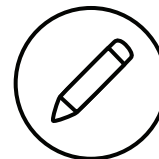

Coloring sheets



Tree house
connect-the-dots

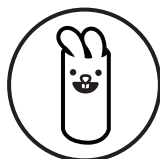

Pilot Jack

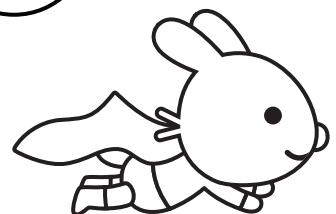

**SUPER
JACK**

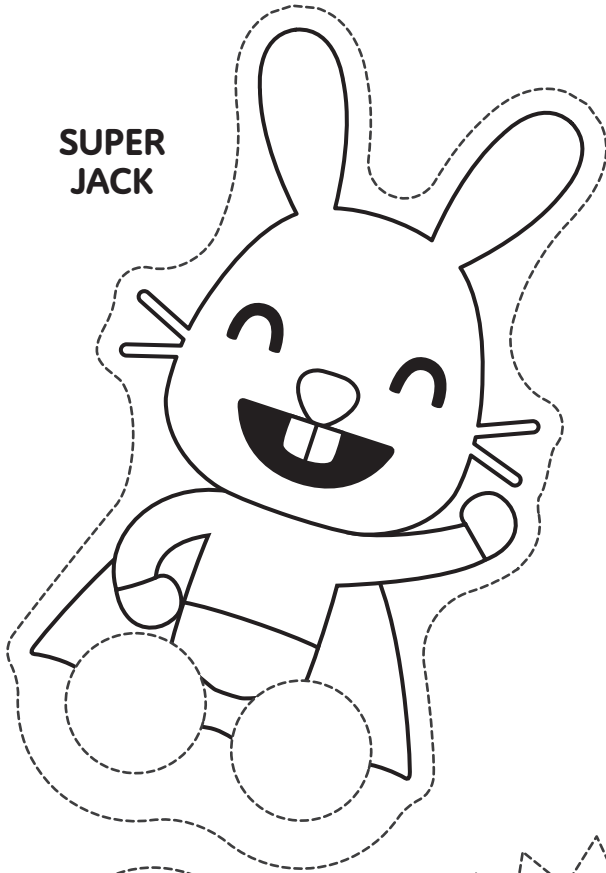

HELIPAD

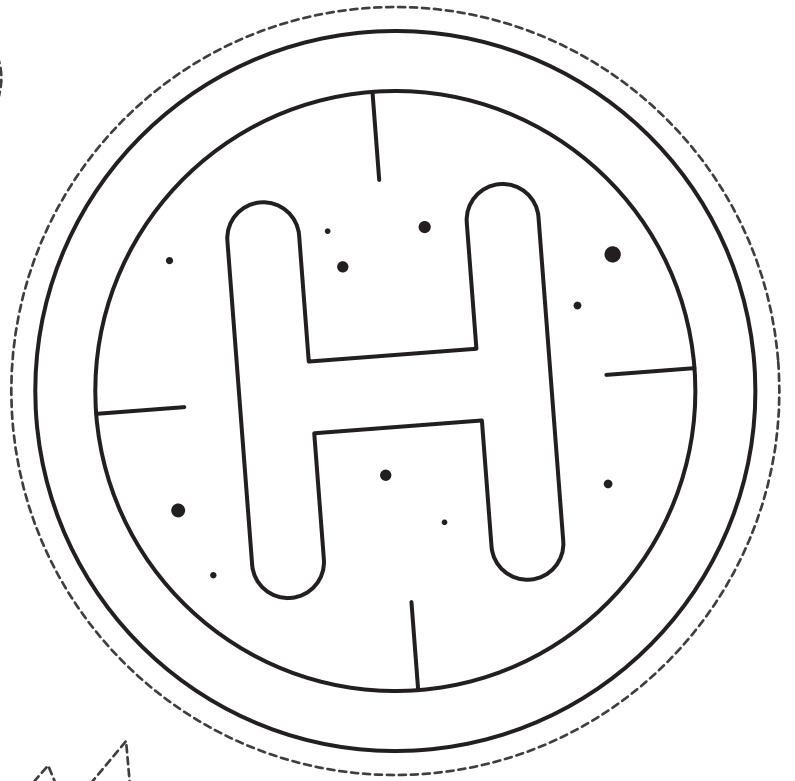

WHOOSH!



BAM!



**CARROT
JUICE**

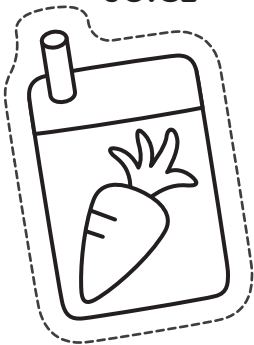

**CARROT
COPTER**

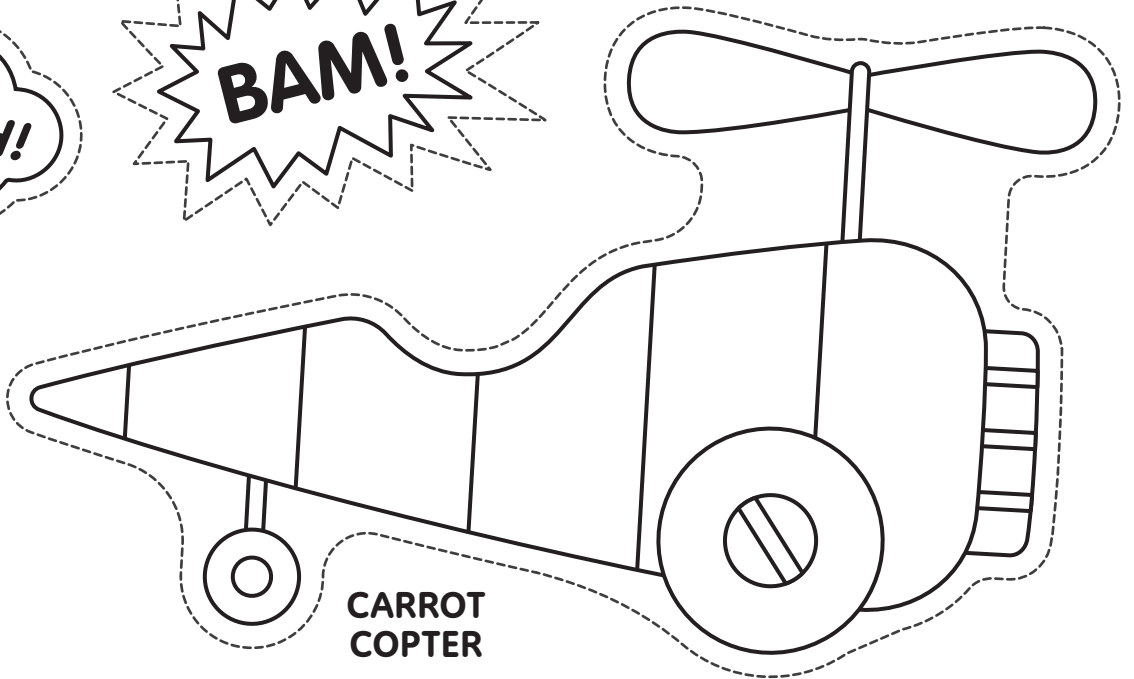

Instructions:

Color and cut out along the dotted line. Have an adult cut out the holes. Slot the stand into the wave so it can stand up. Place your fingers into the holes and save the day!



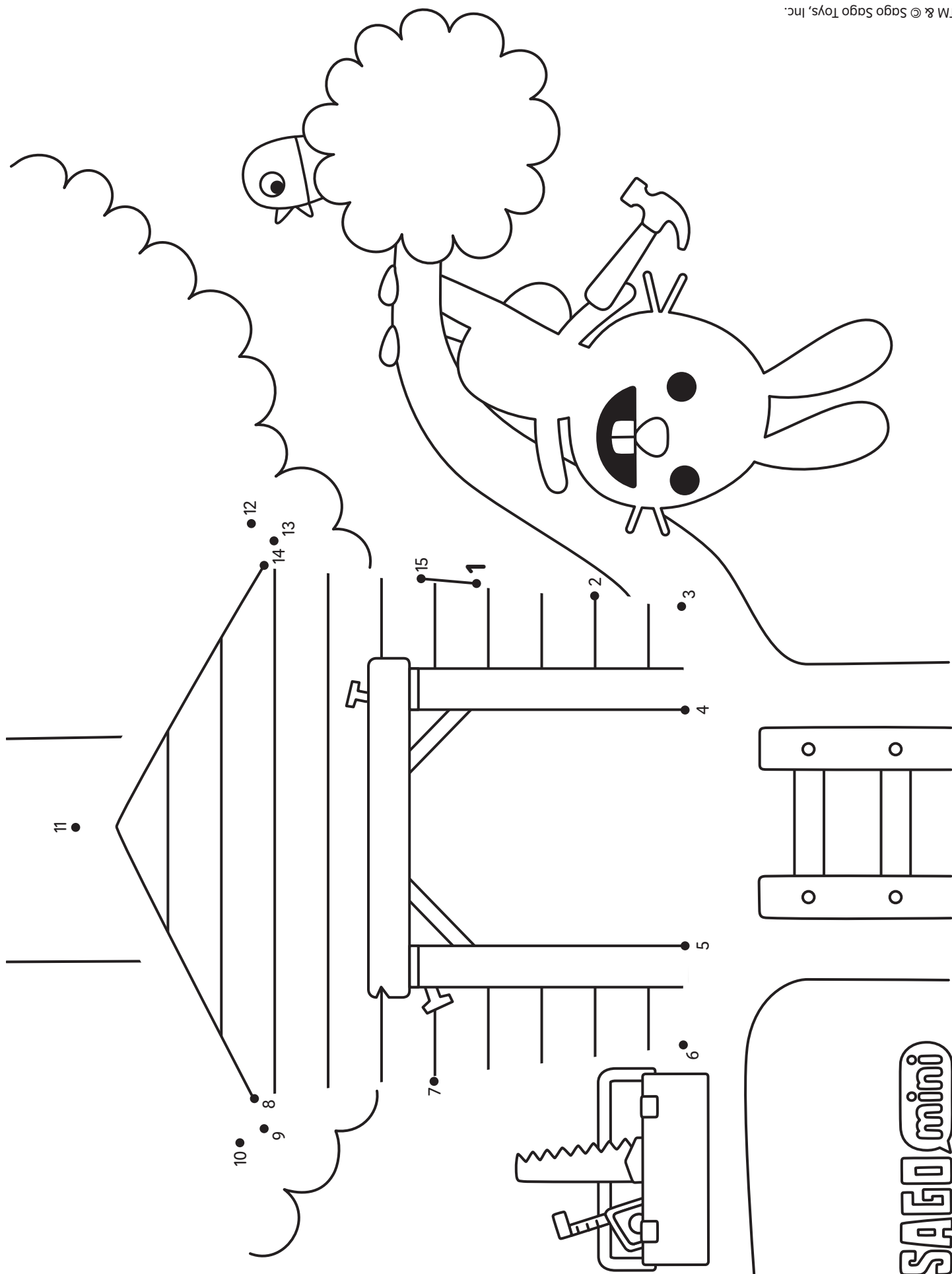

SAGOmini

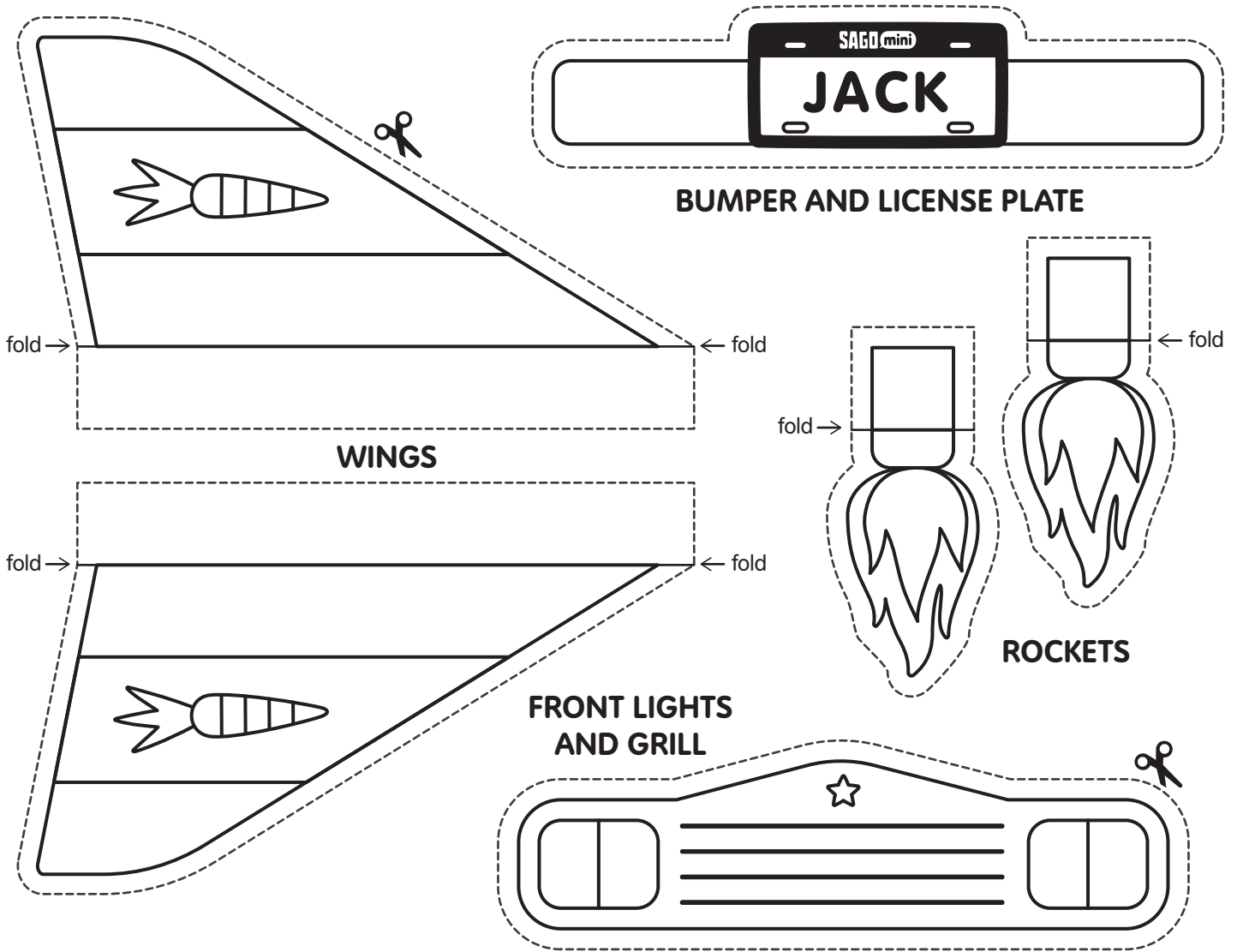

Tissue box rocket car & pilot Jack instructions

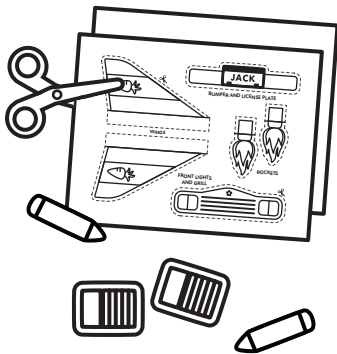

1. Print, color, and cut
Print out the activity and color it in. Cut out the pieces along the dotted line.

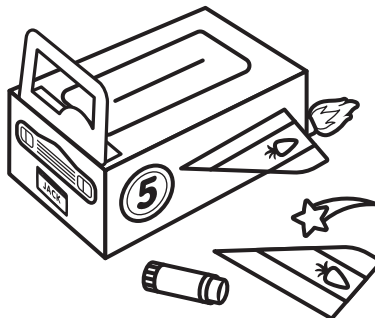

2. Rocket car
Find an empty tissue box and glue the rocket car pieces onto the outside of the box.

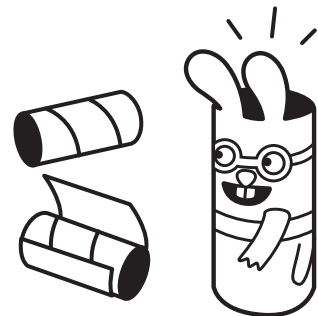

3. Pilot Jack
Wrap toilet paper tube in the Pilot Jack cover and secure with glue. Blast off!

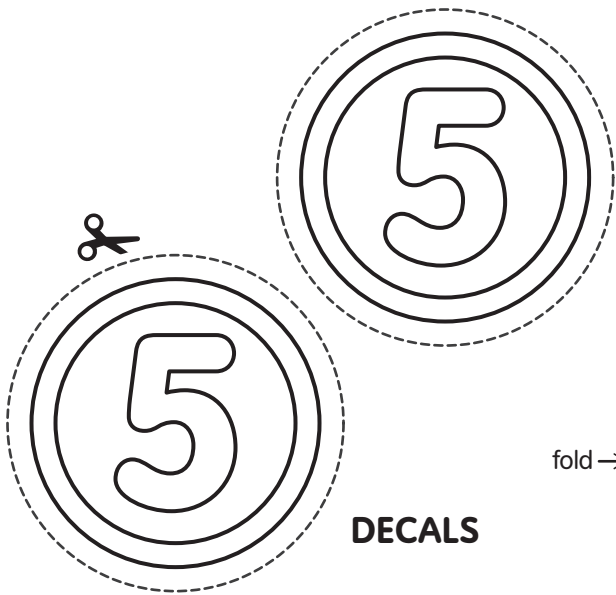

DECALS

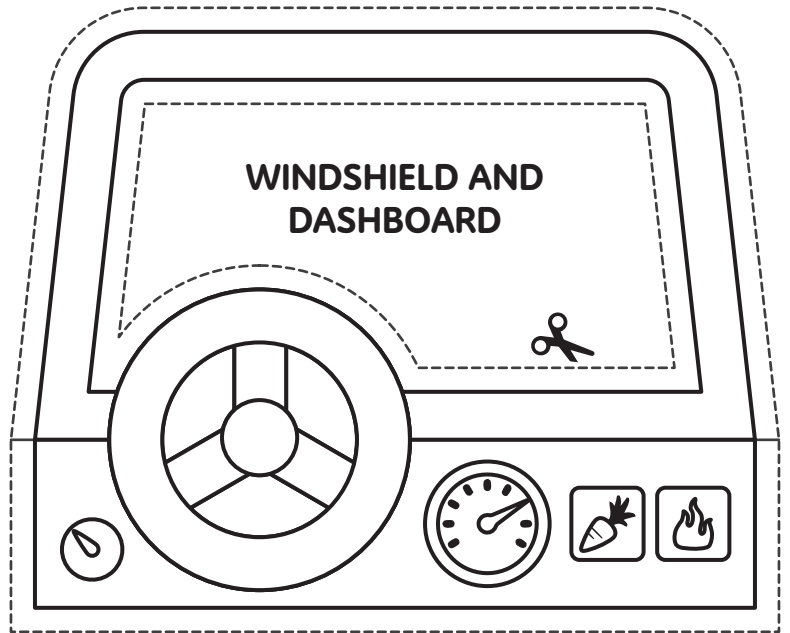

WINDSHIELD AND
DASHBOARD

fold →

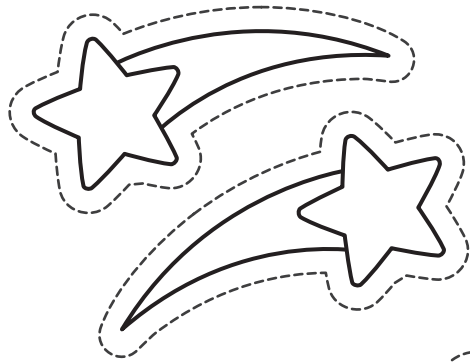

BUMPER AND LICENSE PLATE

PILOT JACK
(TUBE COVER)

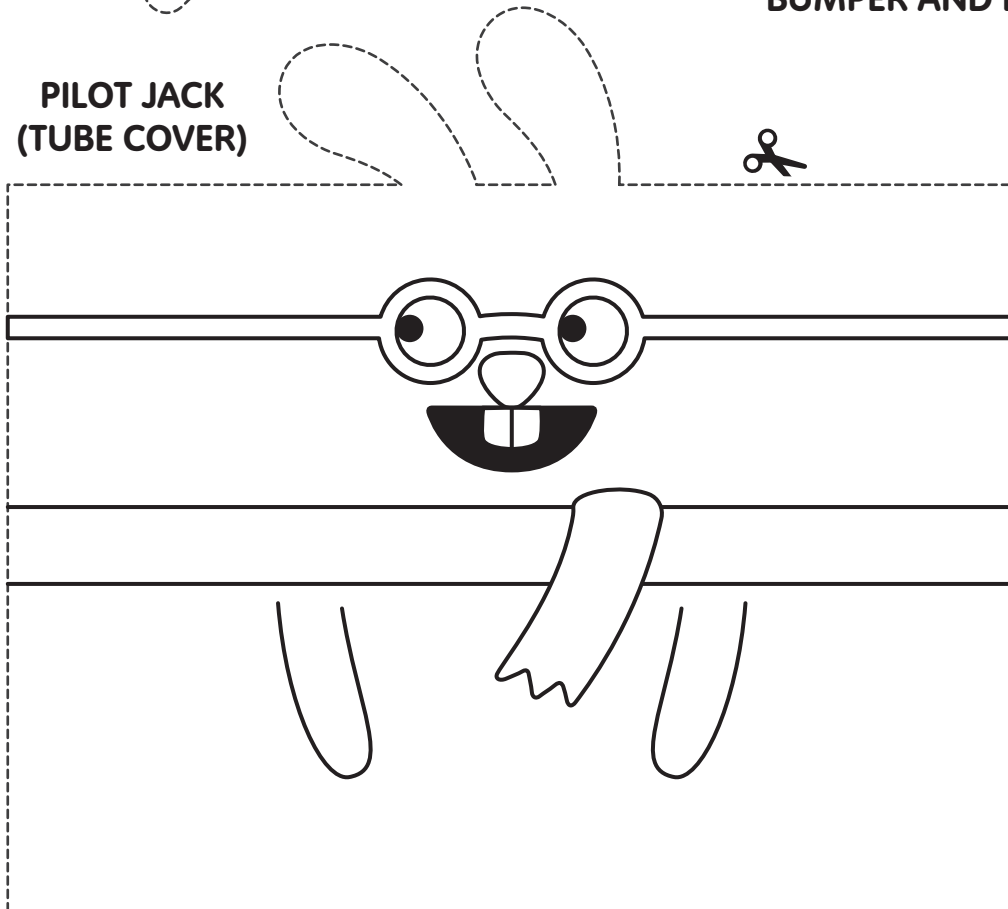

TAIL LIGHTS

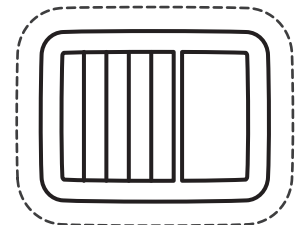
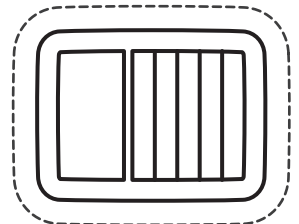



SAGO mini

