

# Winter Break Pack

We've got you covered with a week's worth of winter themed activities!

**What do you call it when a snowman has a temper tantrum?**  
A meltdown!

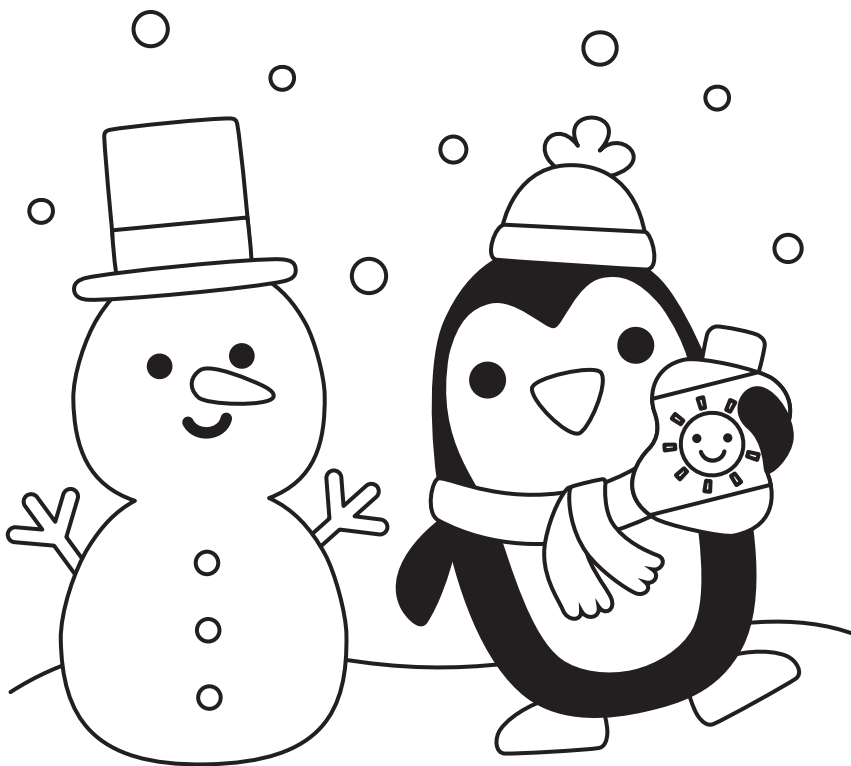

## Daily activities:

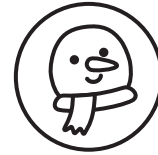

**Day 1:** Make and dress up a paper snowpal

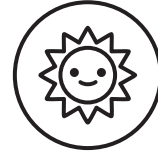

**Day 2:** Pretend you're on a beach vacation



**Day 3:** Color some winter pictures of the Sago Mini gang



**Day 4:** Play a game of winter charades



**Day 5:** Craft a pompom sweater for Neville



**Day 6:** Learn about symmetry and make snowflake puzzles



**Day 7:** Dress Harvey up with winter and summer outfits



**SAGO mini**  
**printables**

## Supplies you'll need:



crayons



scissors



glue stick



pom poms

Thoughtful design brought to life. For kids. For parents. For giggles. Discover more at [sagomini.com](http://sagomini.com)

# Day 1: Paper Snowpal

## Instructions

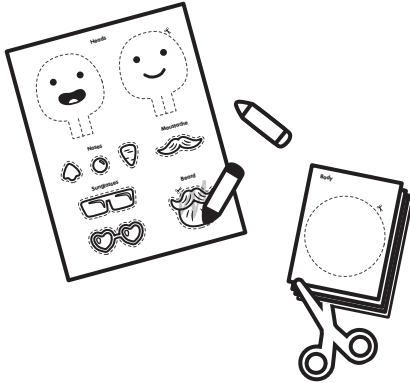

### 1. Print, color & cut out

Print out the activity and color. Cut out all the pieces along the dotted lines.

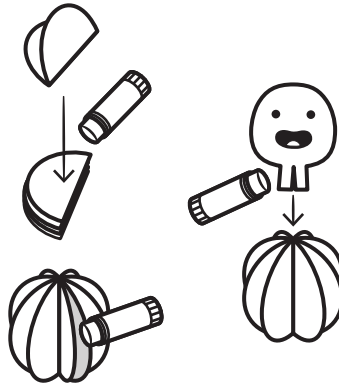

### 2. Make the snowpal

Fold the body pieces in half and glue the halves to each other. Open up the pieces and glue the last piece to the first piece, then open it to make a sphere. Slot and glue the head on top.

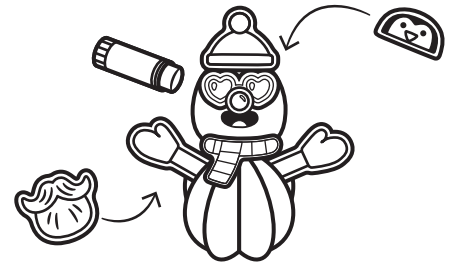

### 3. Dress up!

Mix and match face pieces and accessories. Add arms and legs!

## BODY PIECES

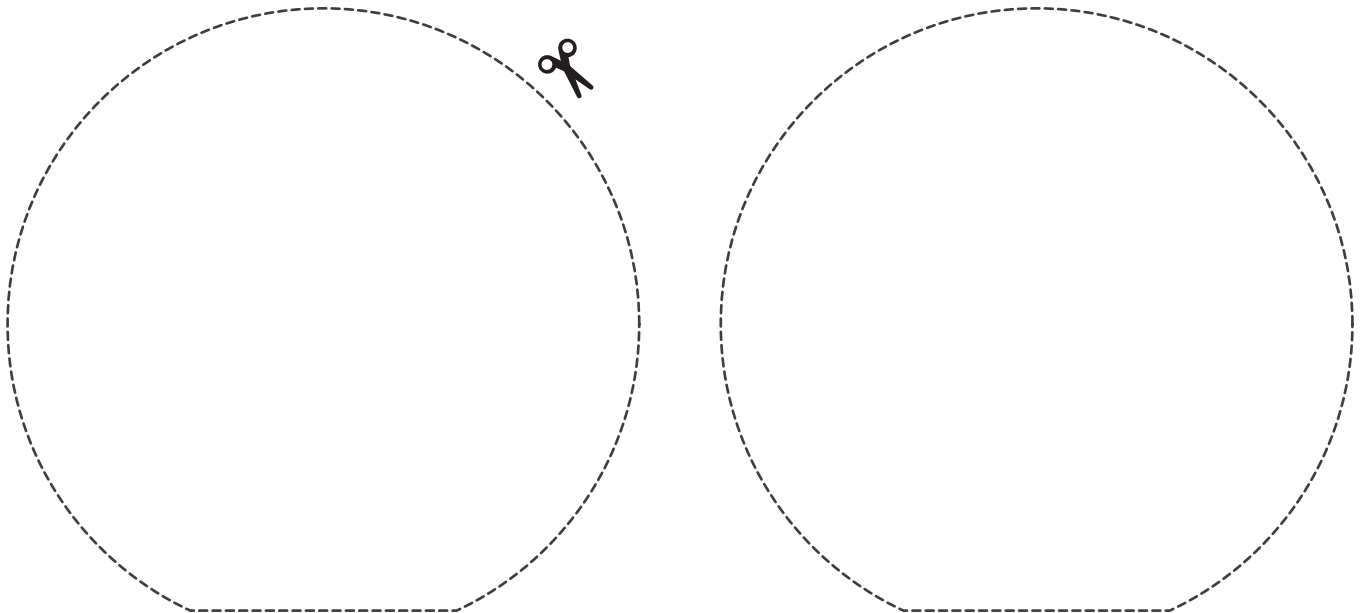

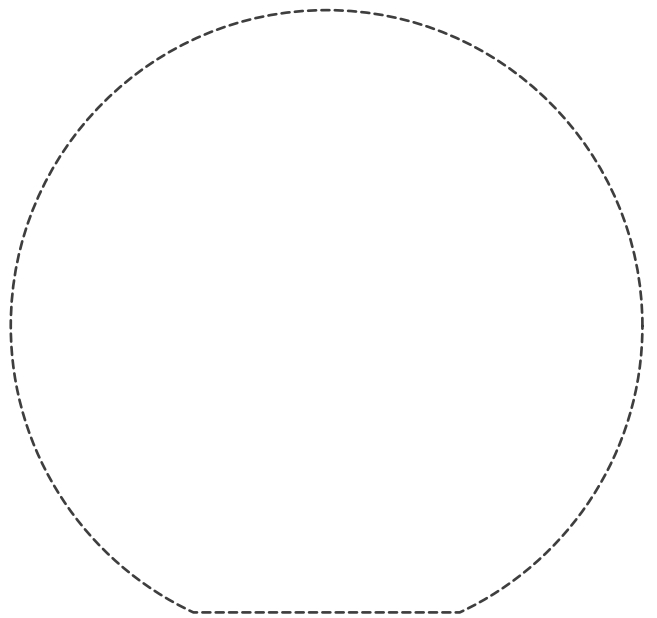
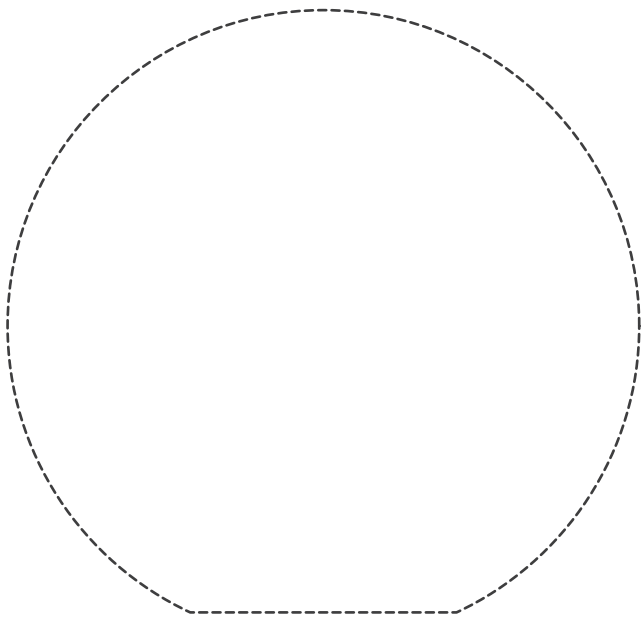
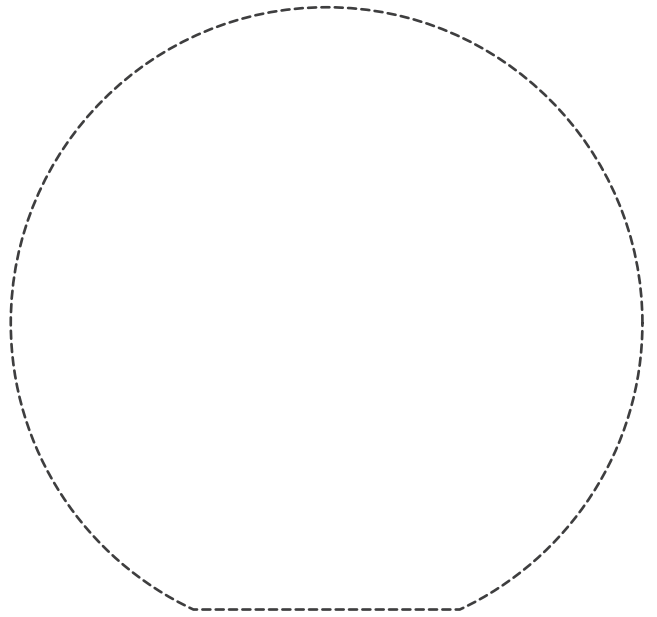
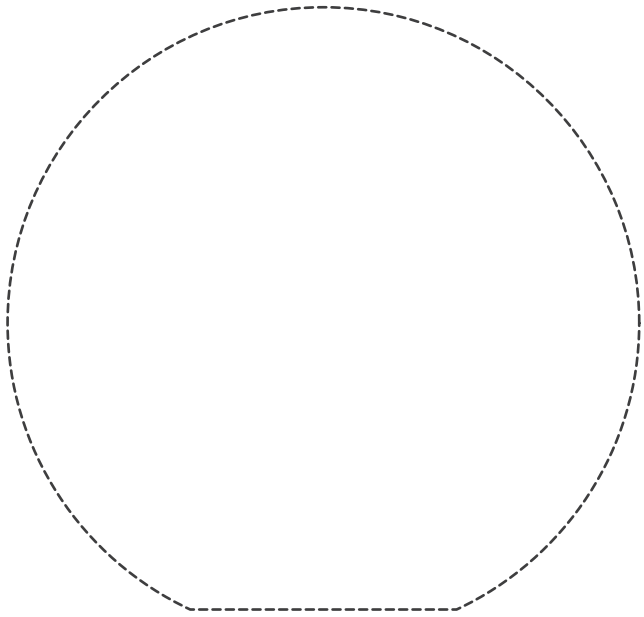
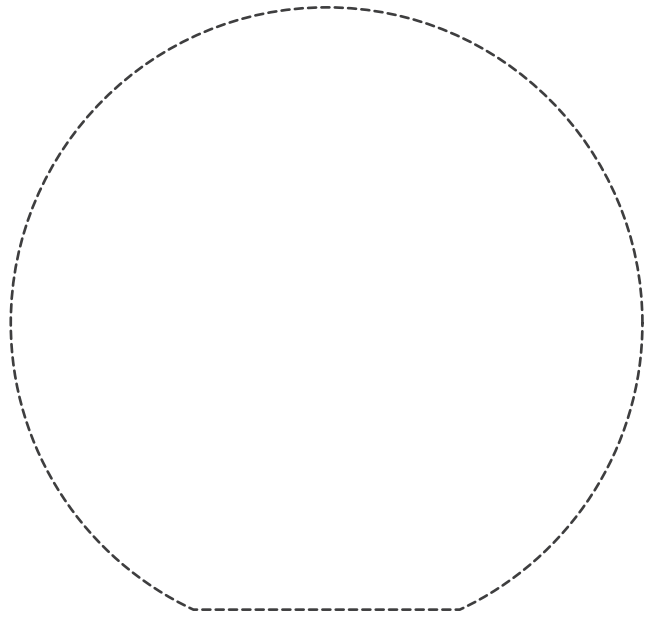
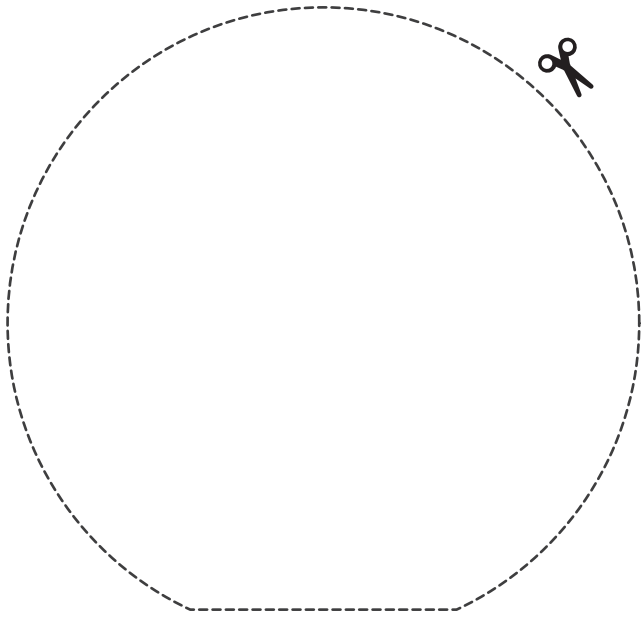

**HEADS**

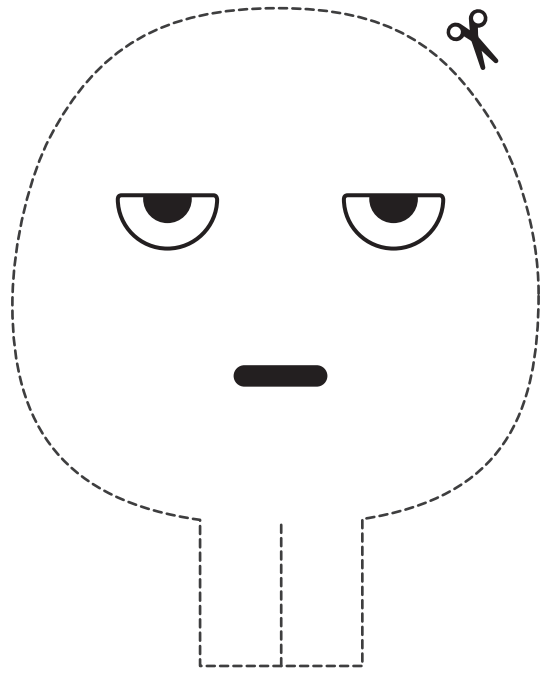
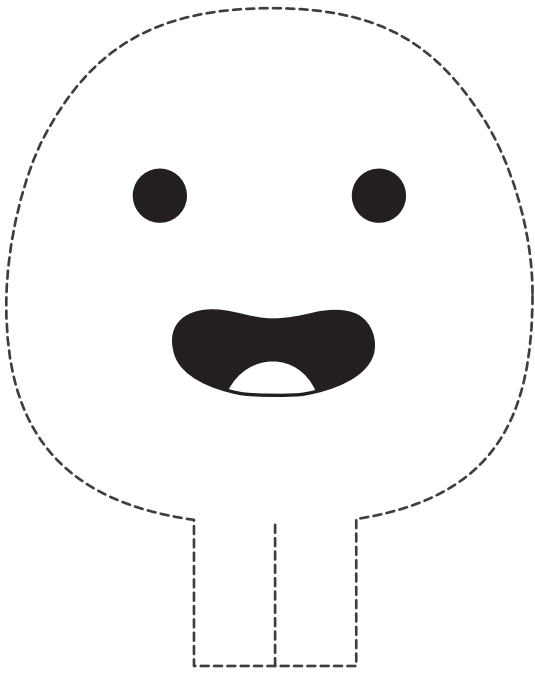

**NOSES**

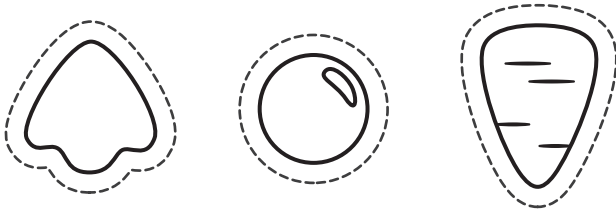

**BEARD**

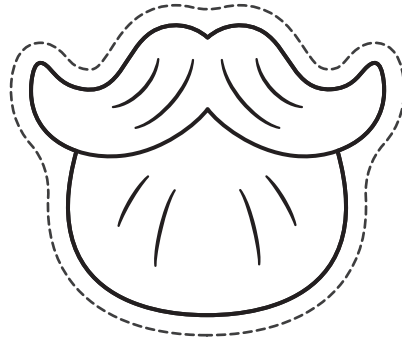

**SUNGLASSES**

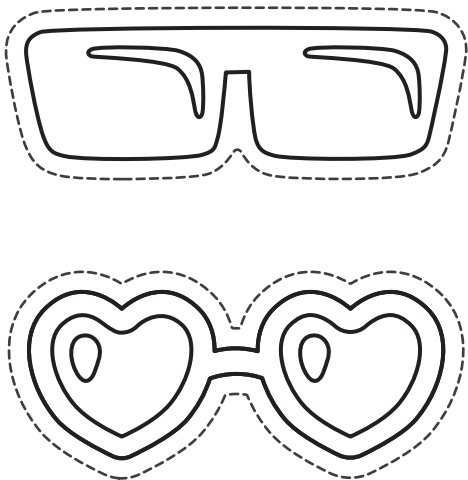

**ACCESSORIES**

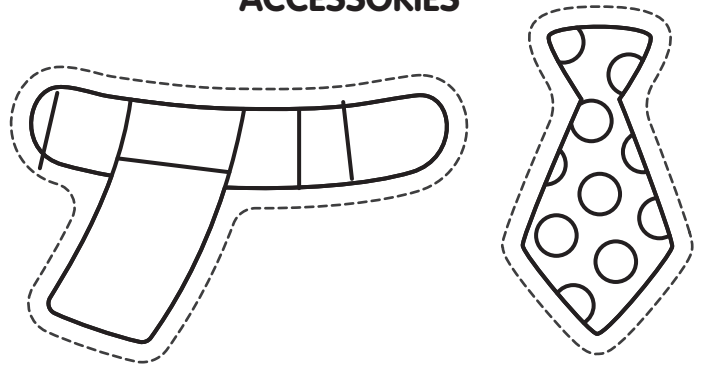

HATS

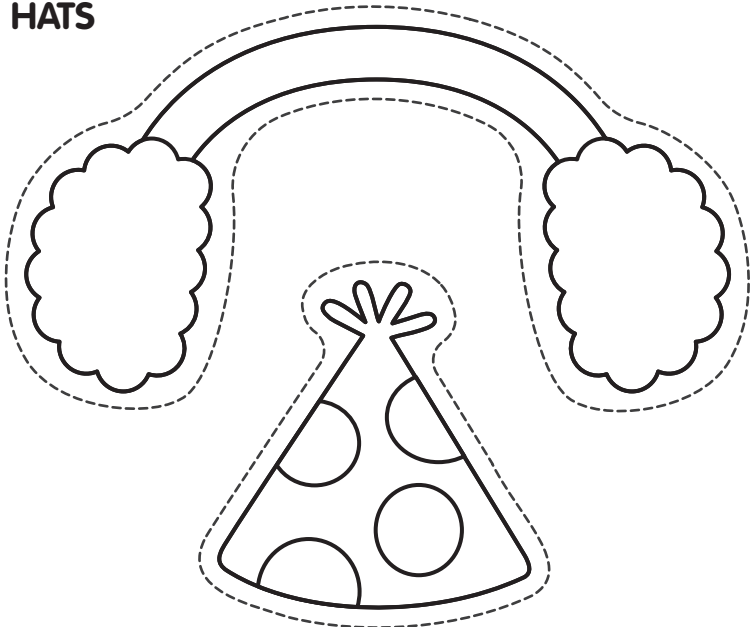
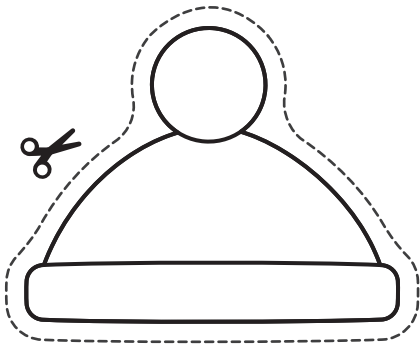

ARMS

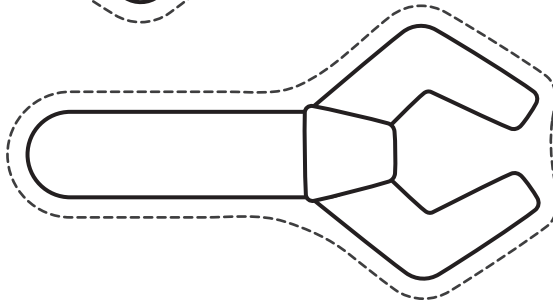
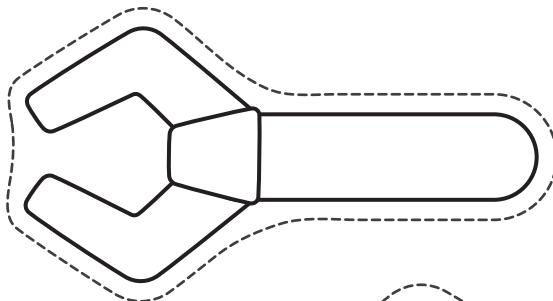
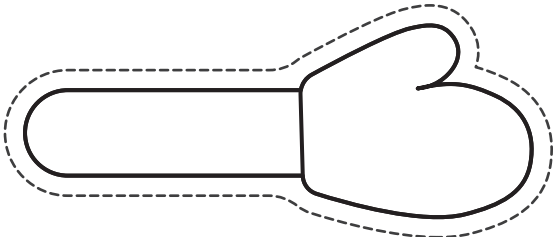
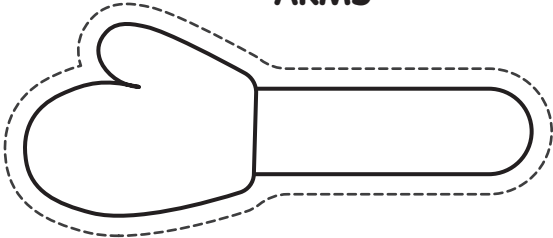

LEGS

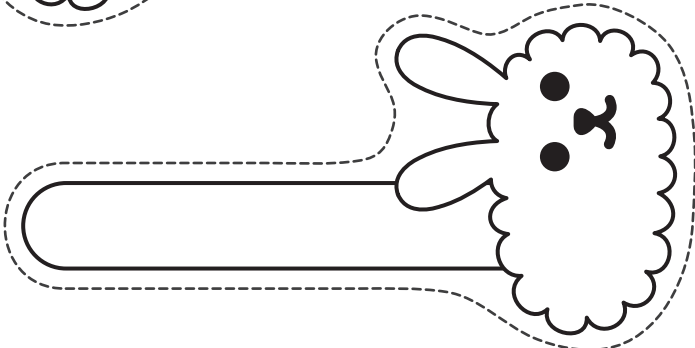
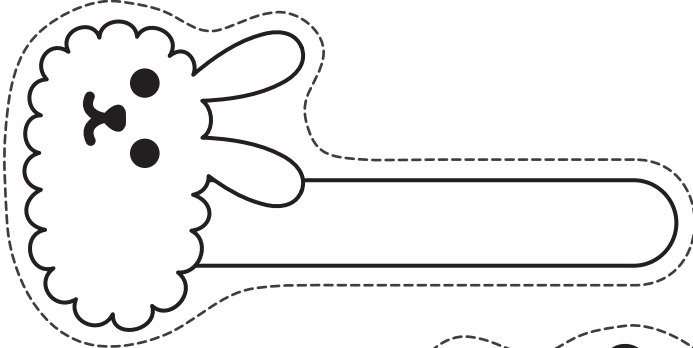
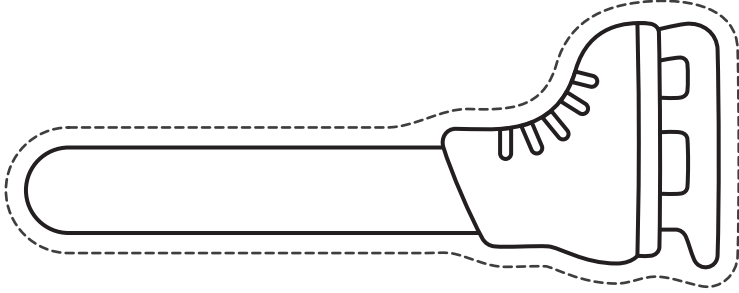
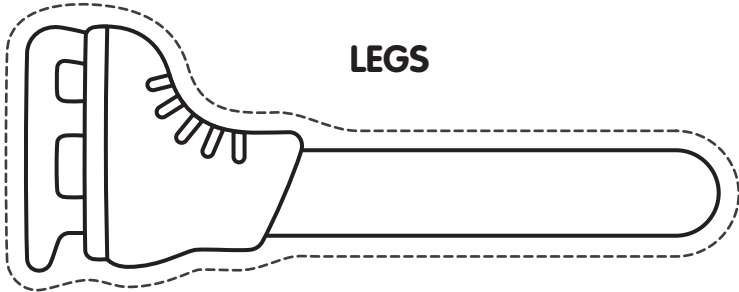

# Day 2: Beach Vacation Kit

## Instructions

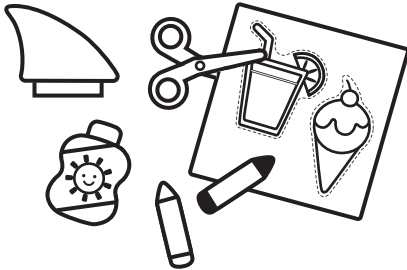

### 1. Color & cut

Color and cut out the beach vacation props. TIP: To make them sturdier, glue the pieces onto cardstock paper before cutting.

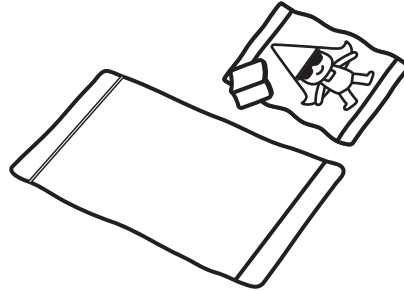

### 2. Find a spot

Go find a big towel and set up your beach vacation spot somewhere in your home.



### 3. Play time!

Set up your props, play some beach sounds on a speaker, and put on a pair of sunglasses to enjoy your pretend vacation!

## SUNBATHING ASTRID

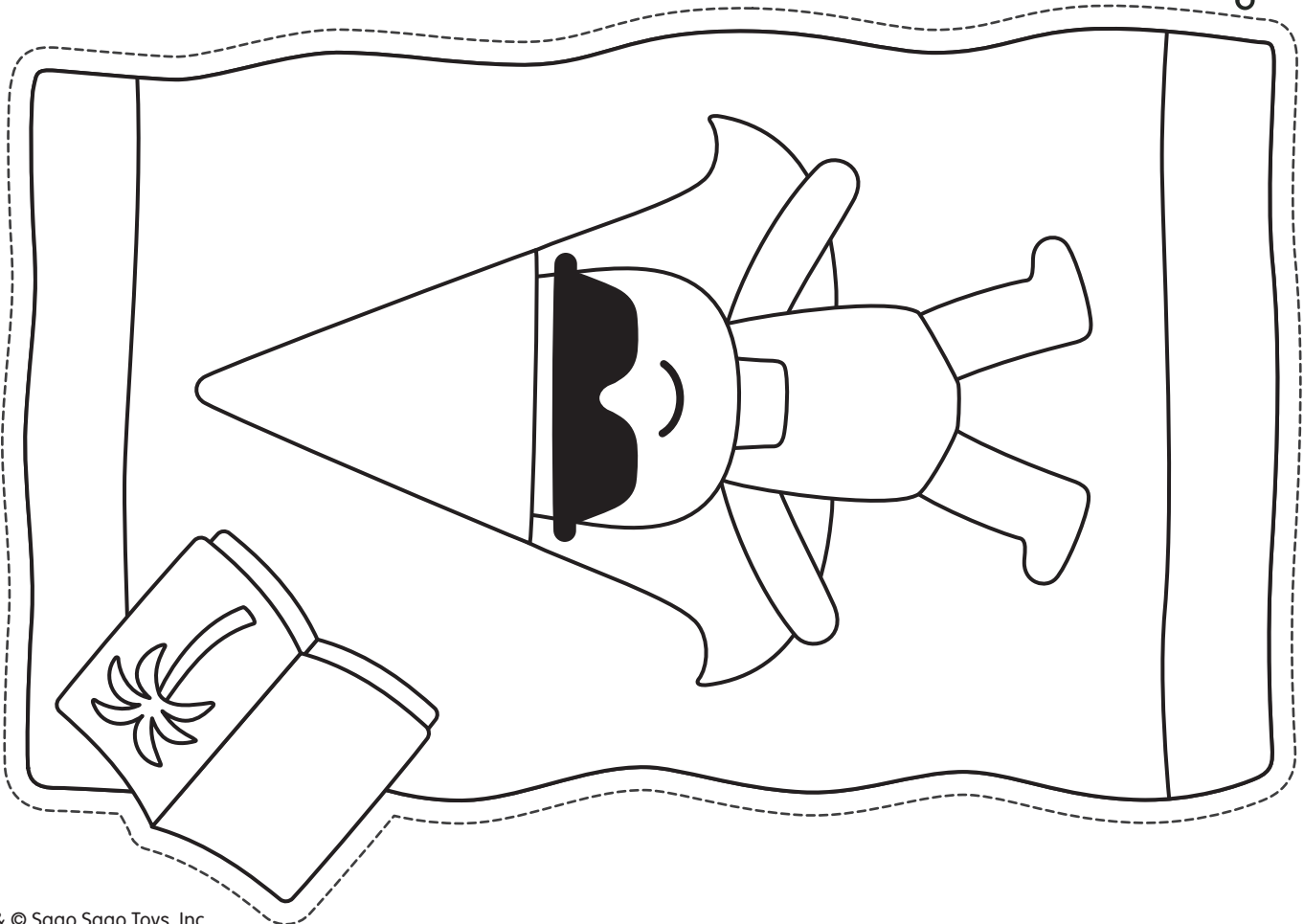

SNACKS

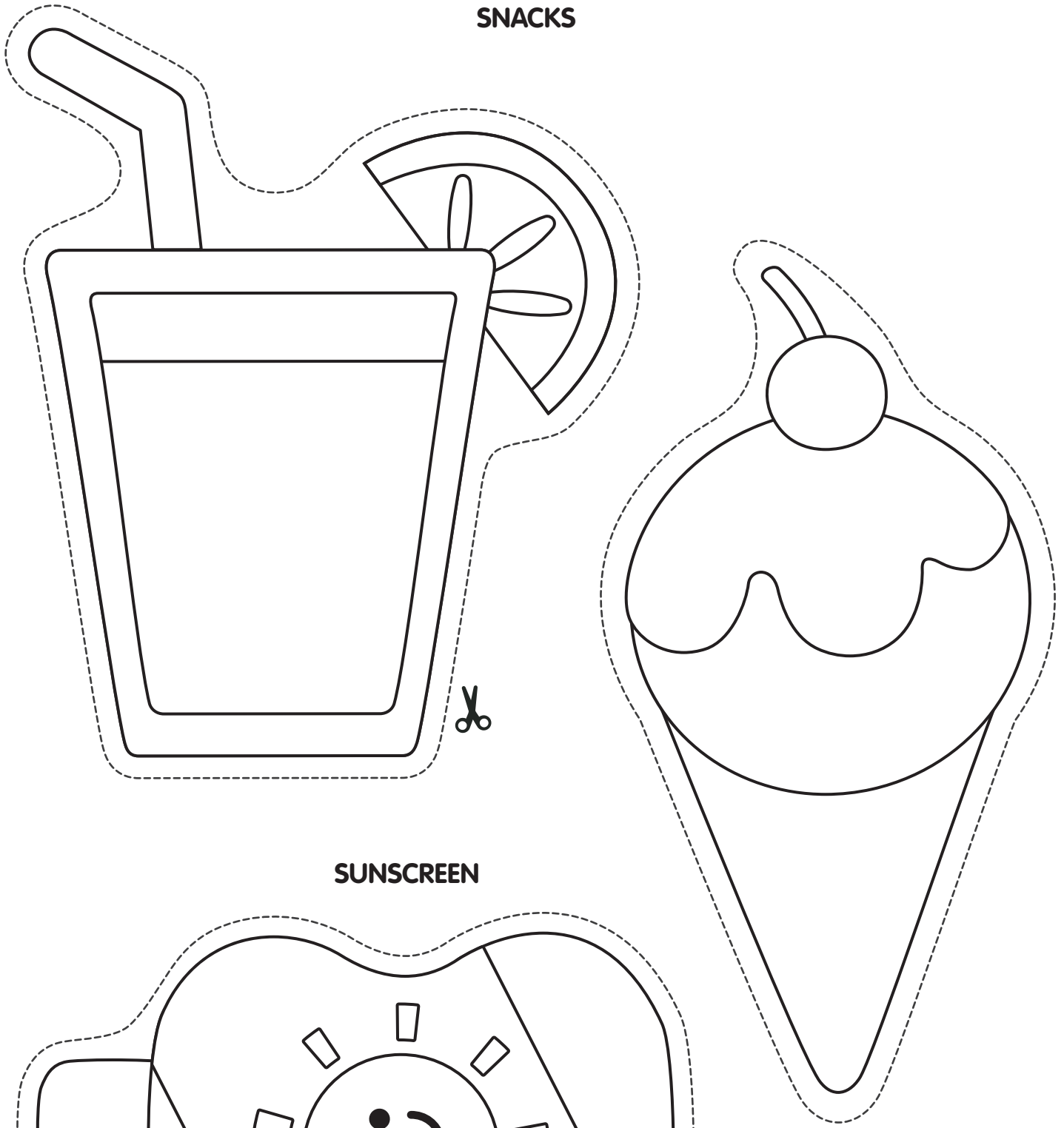

SUNSCREEN

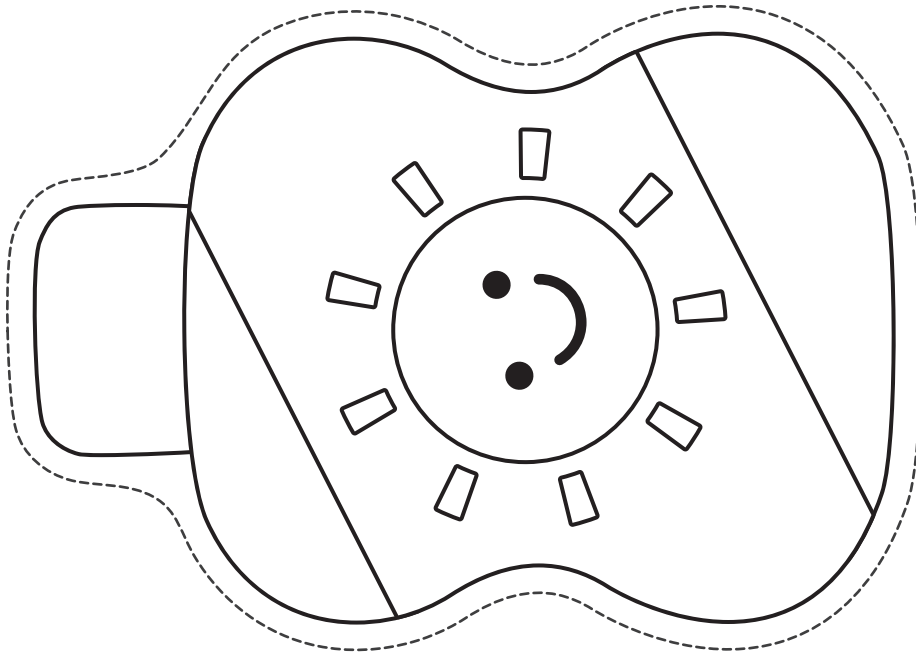

**SAND PAIL**

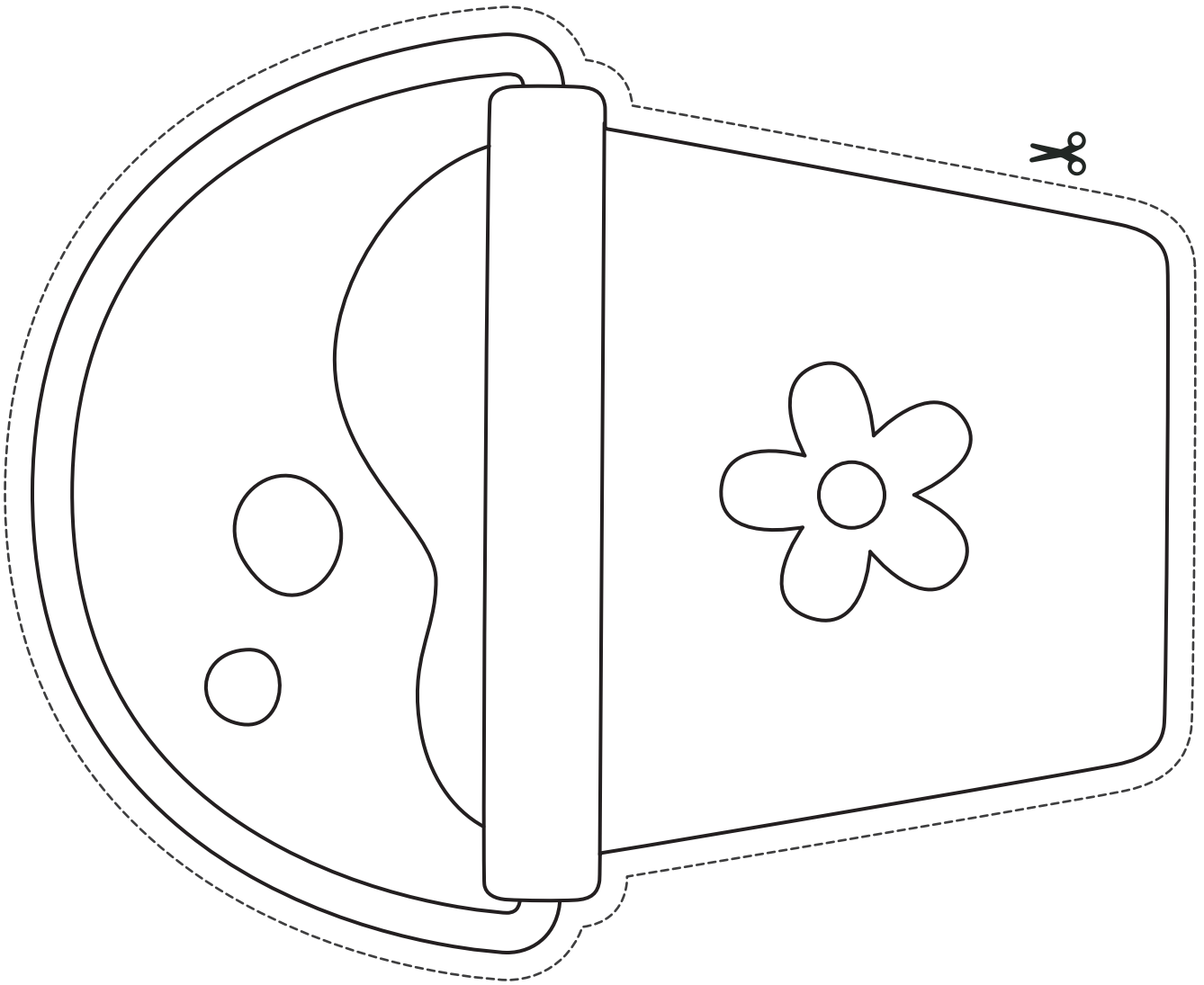

**SHOVEL**

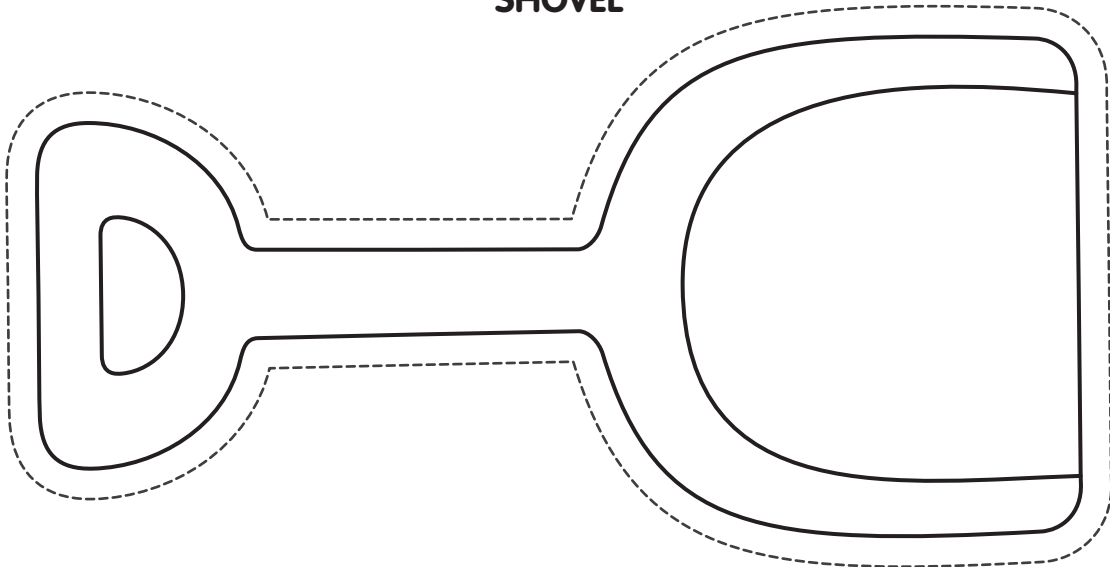



# SHARK FIN

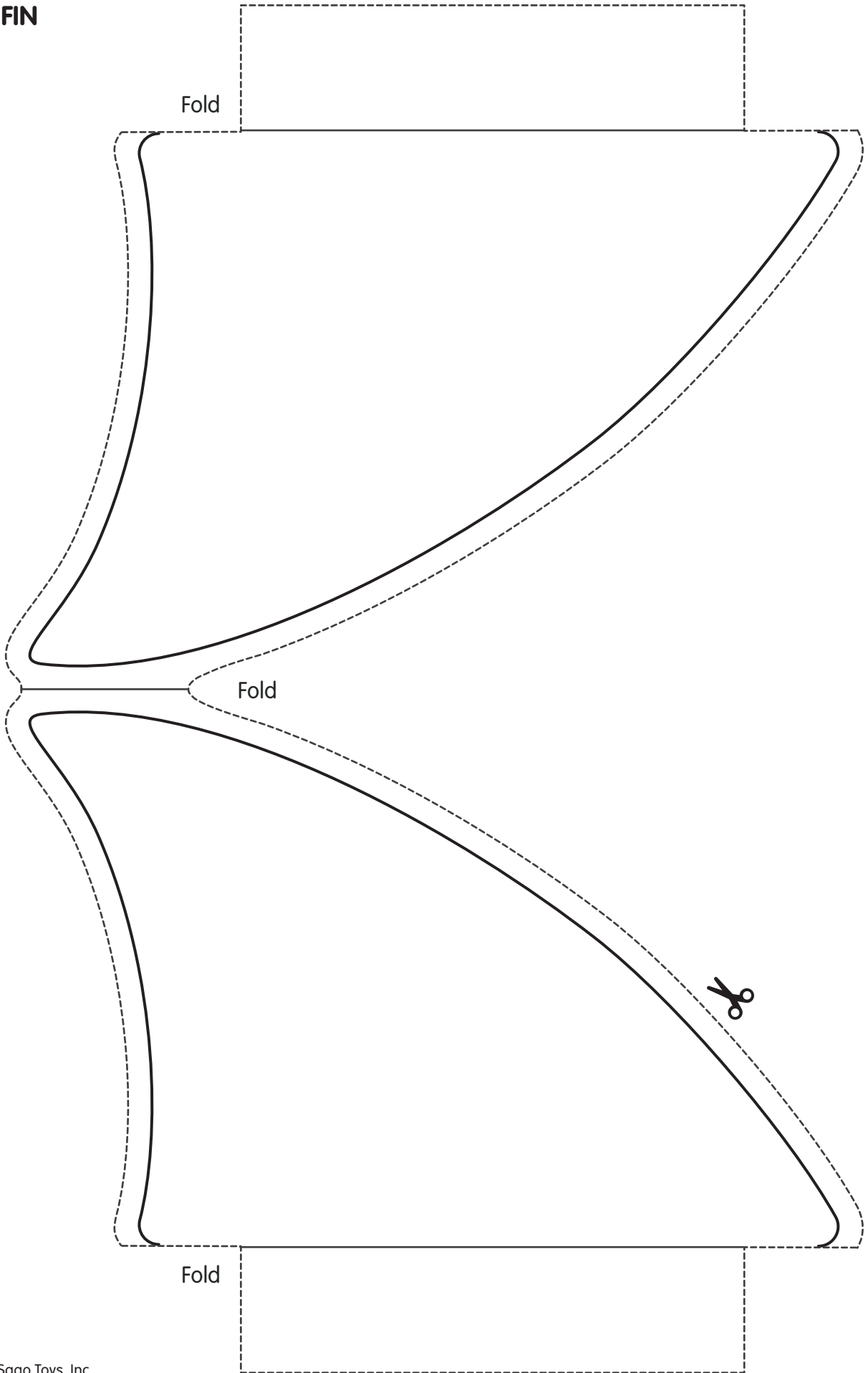

# TREASURE CHEST

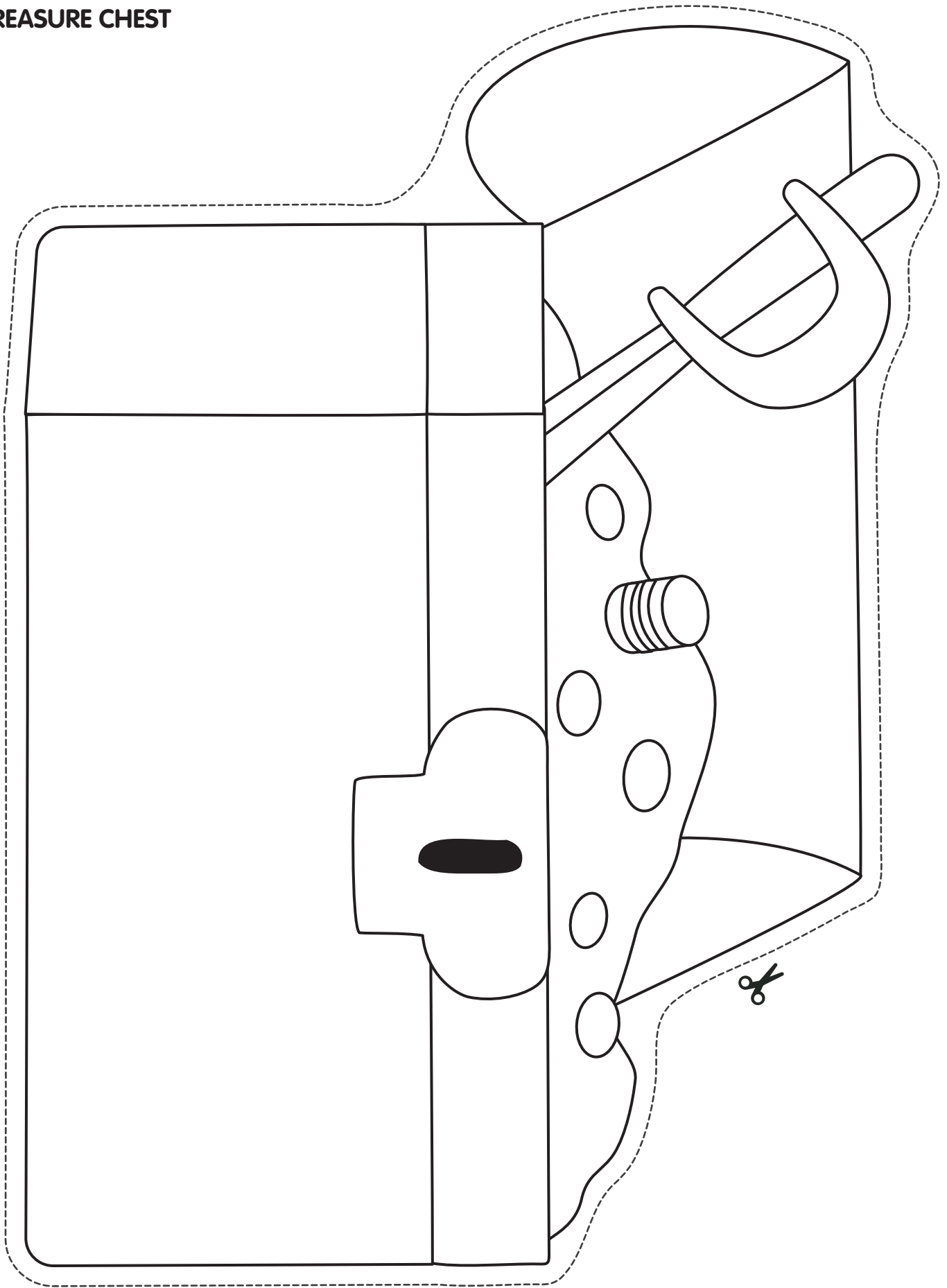

TREASURE MAP

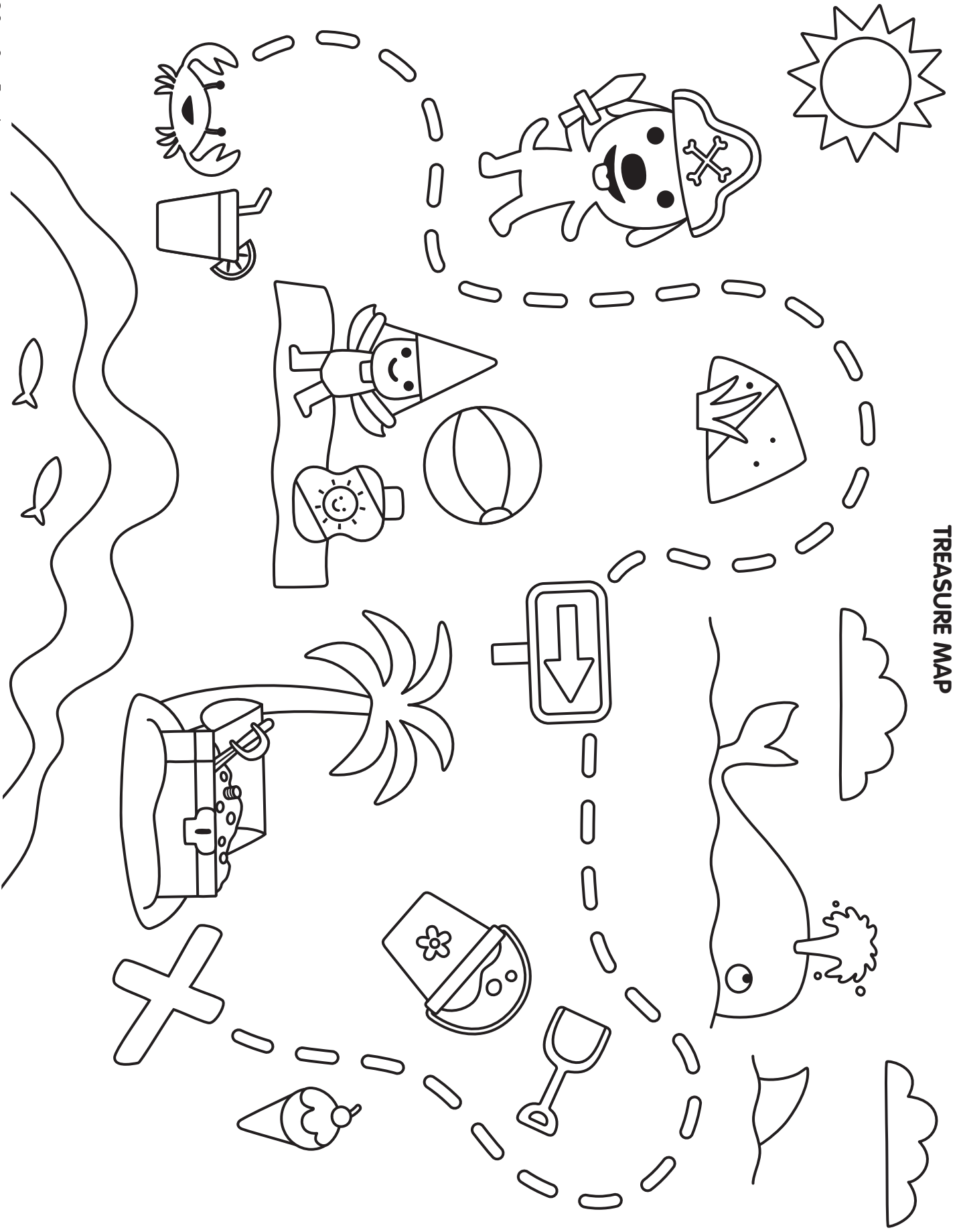

# Day 3: Winter Coloring Sheets

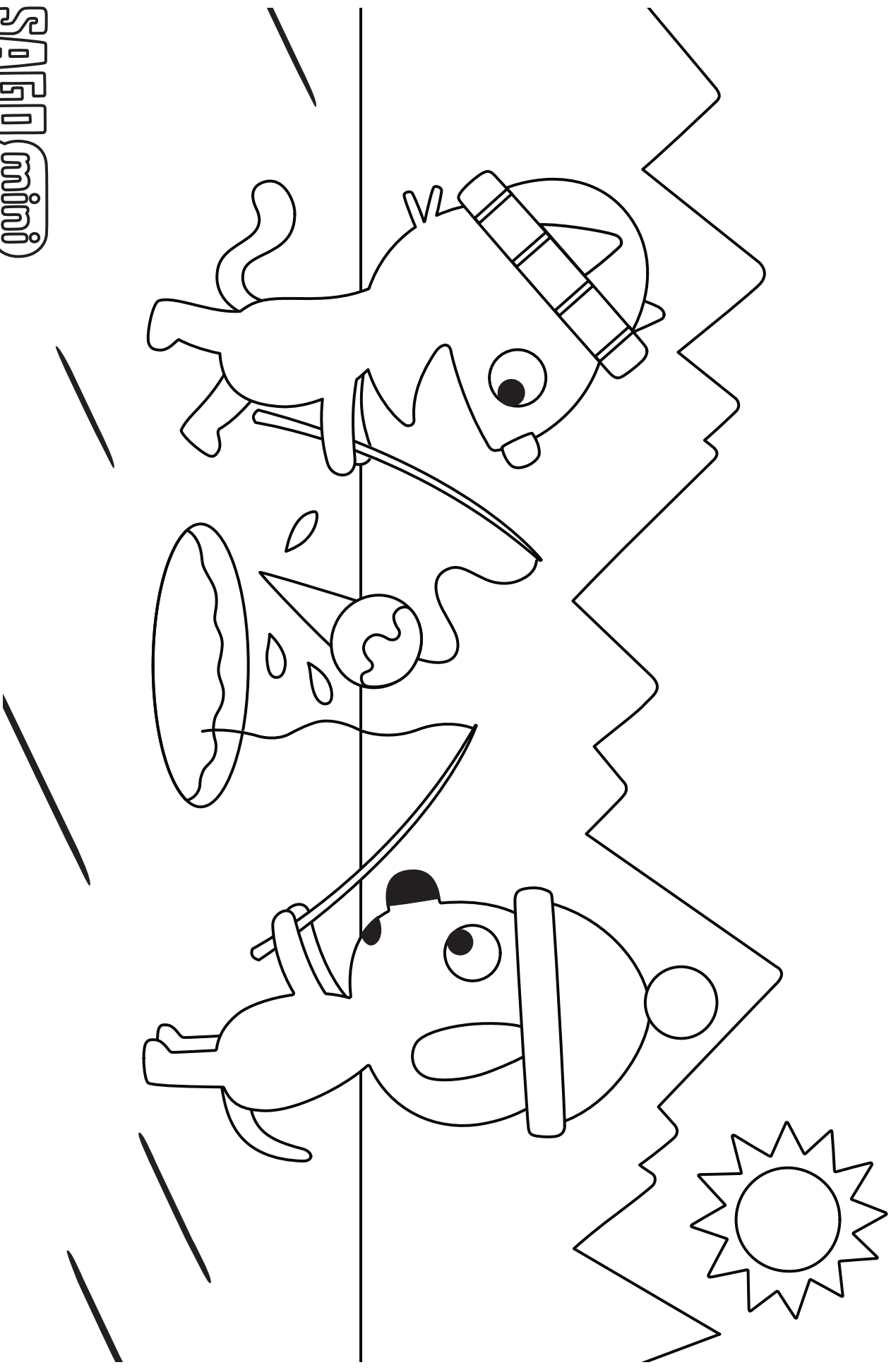

**SAGO**mini

TM & © Sago Sago Toys, Inc.

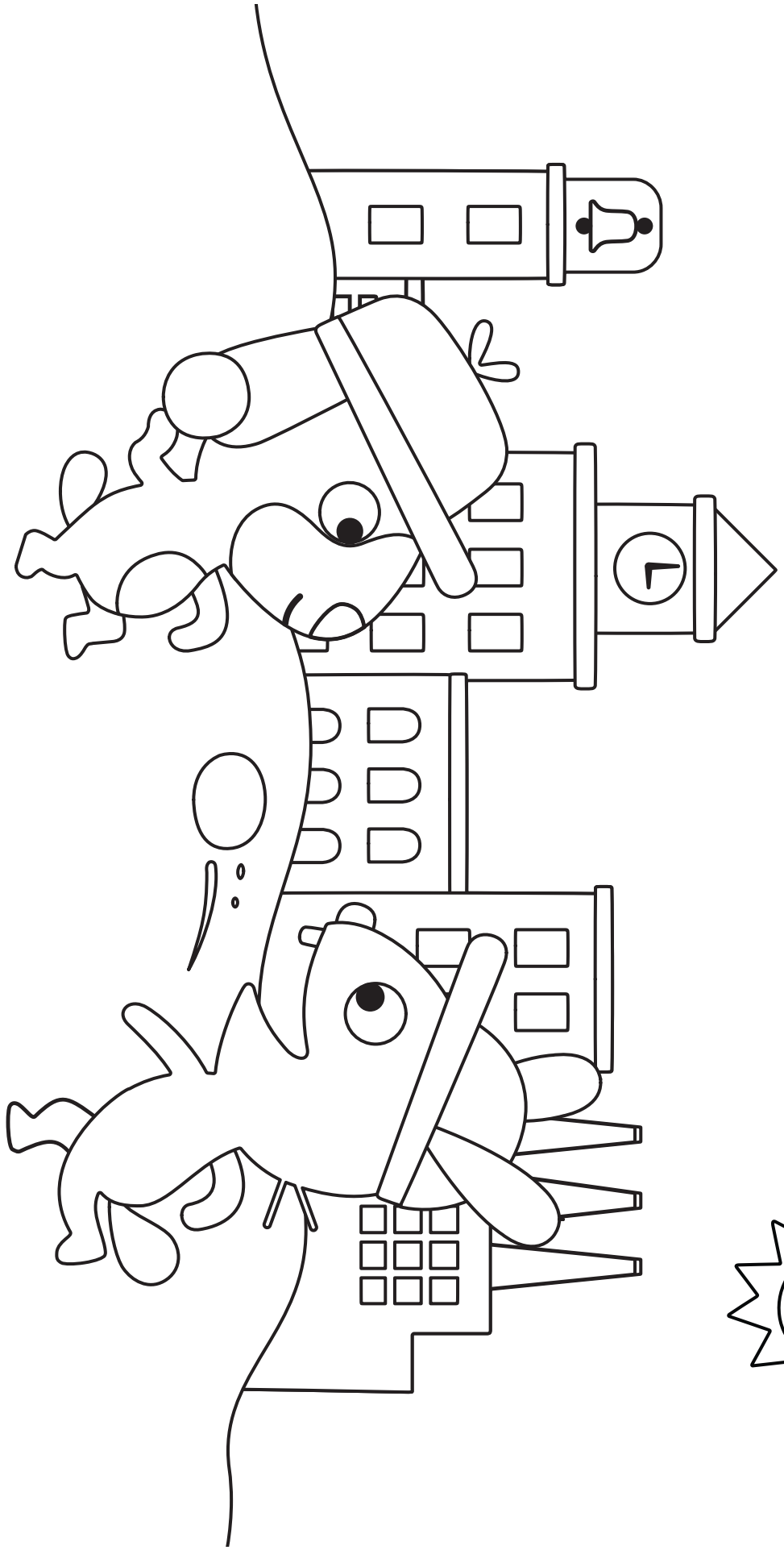
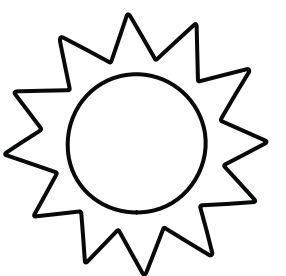

SAGOmini

TM & © Sago Sago Toys, Inc.

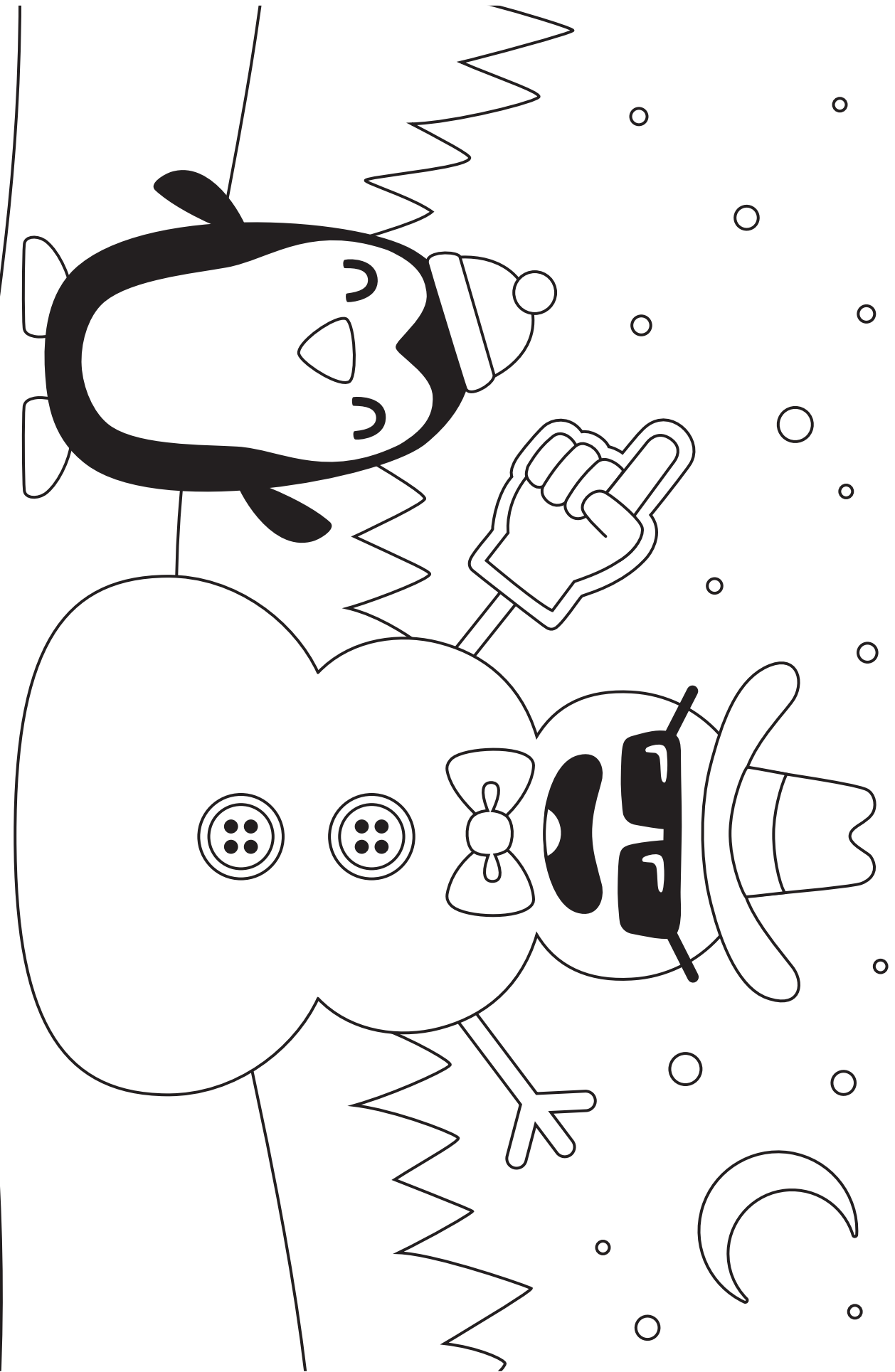

SAGOmini

TM & © Sago Sago Toys, Inc.

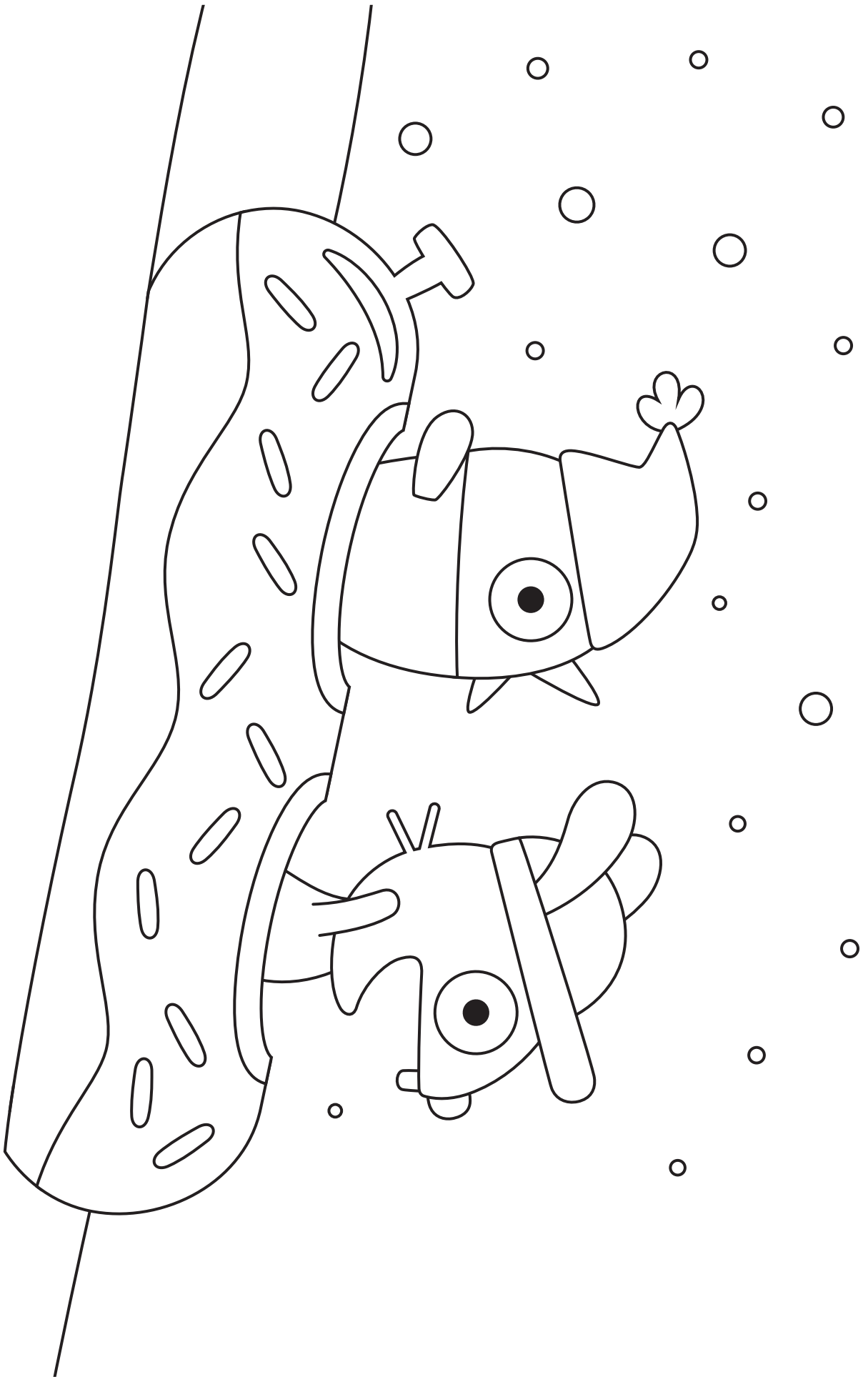

SAGOmini

TM & © Sago Sago Toys, Inc.

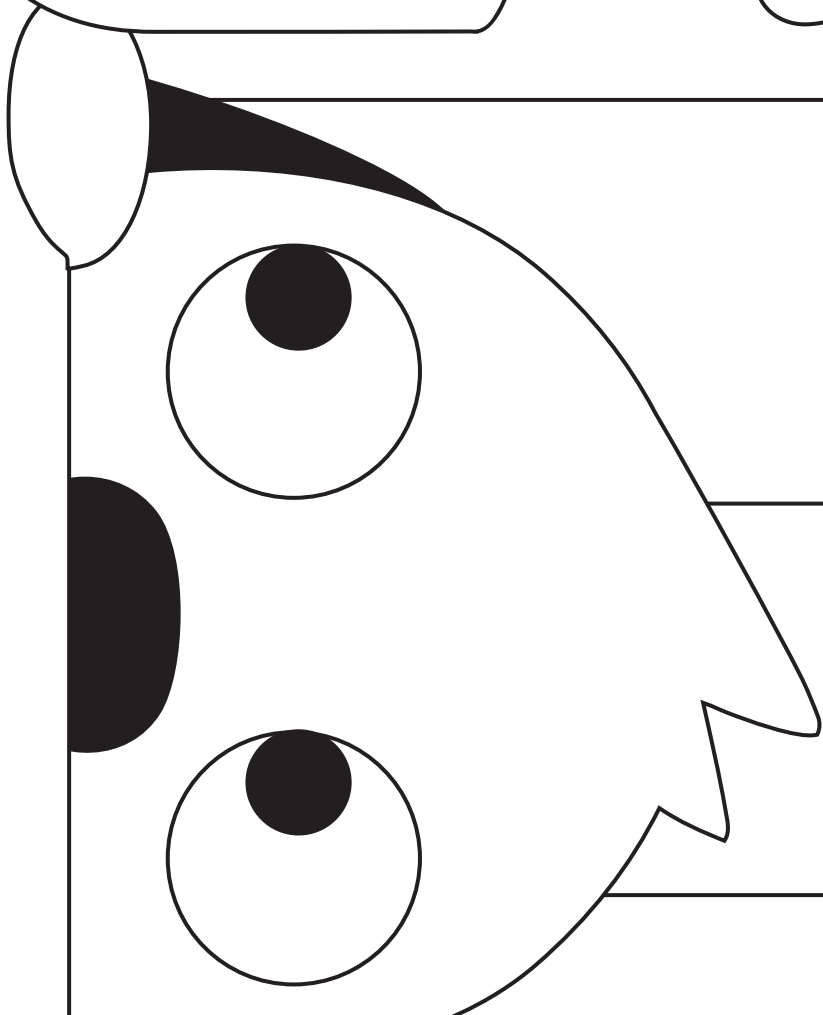
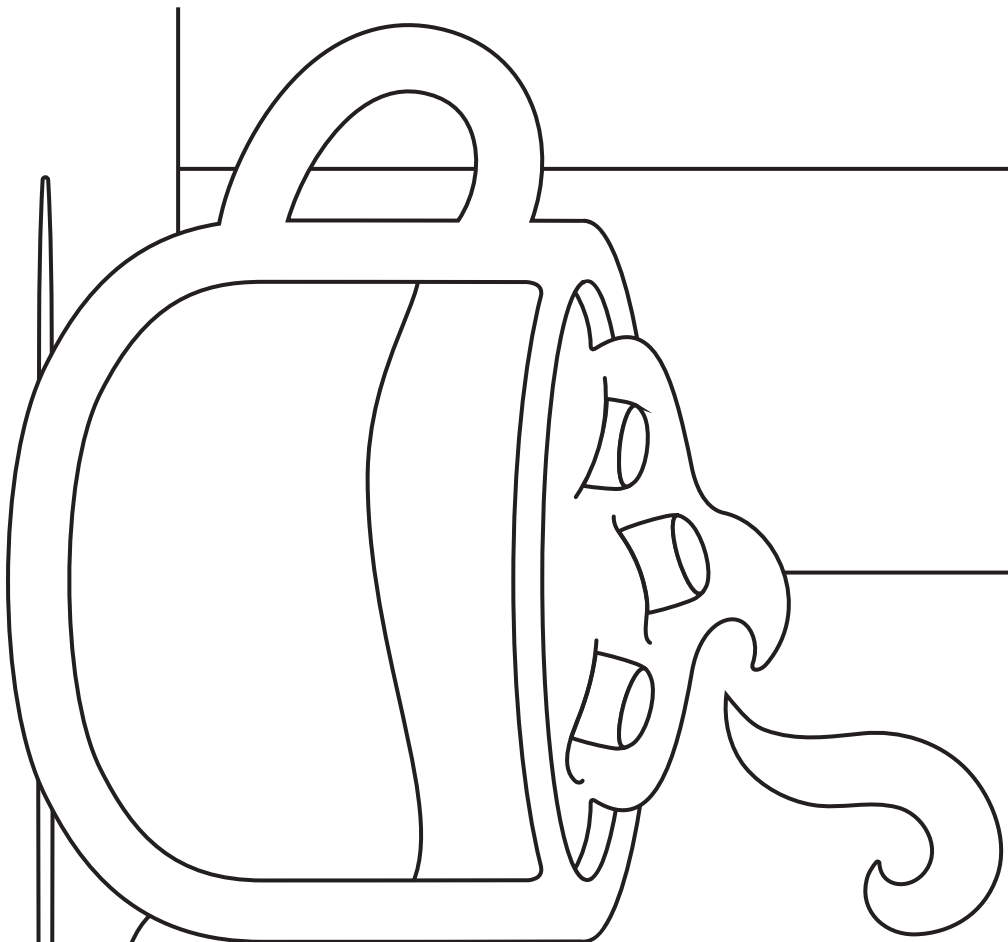

SAAGO mini



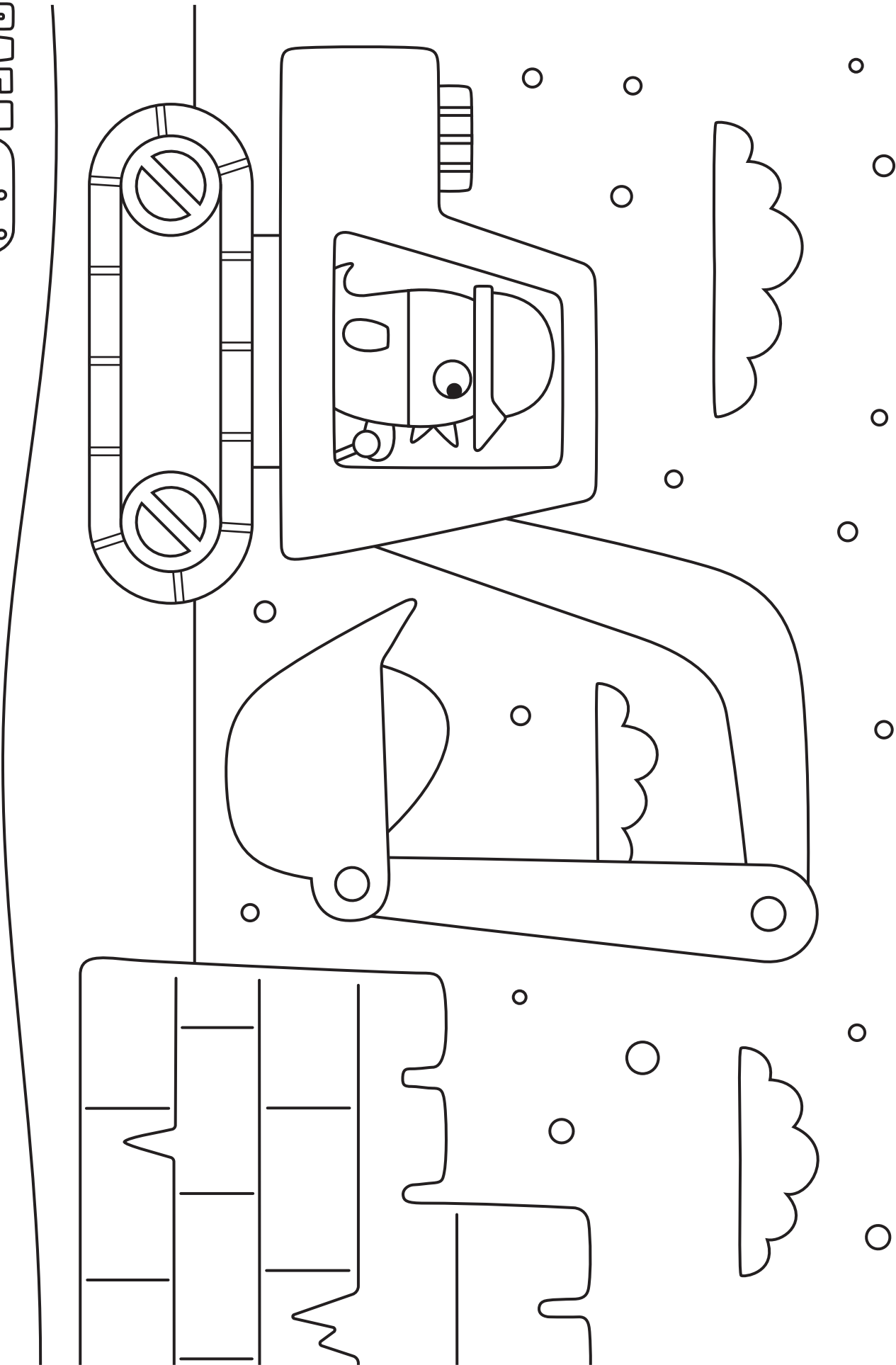

SAGOmini

TM & © Sago Sago Toys, Inc.

# Day 4: Winter Charades



## SAGO mini printables

### Instructions:

Color and cut out the charades cards. Get a winter hat and put the cards inside. Take turns drawing cards from the hat and act out the winter activity for others to guess!

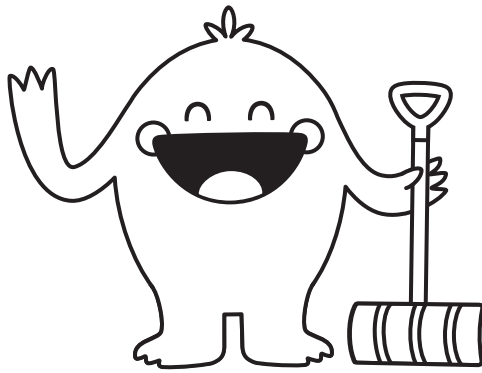

**Shovelling snow**

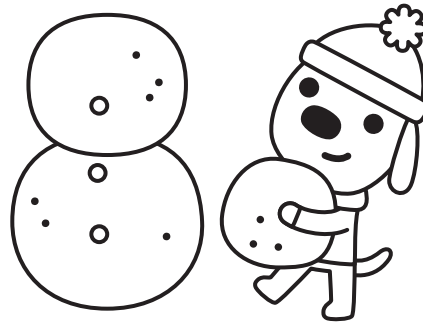

**Making a snowpal**

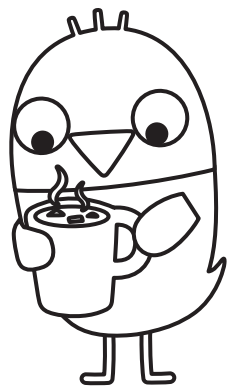

**Drinking hot cocoa**

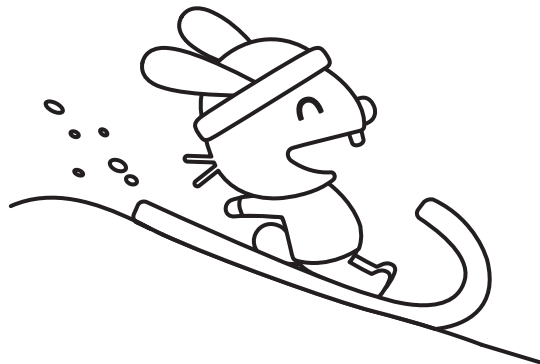

**Sledding**

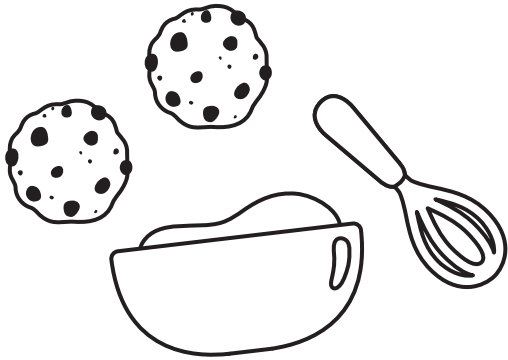

**Baking cookies**

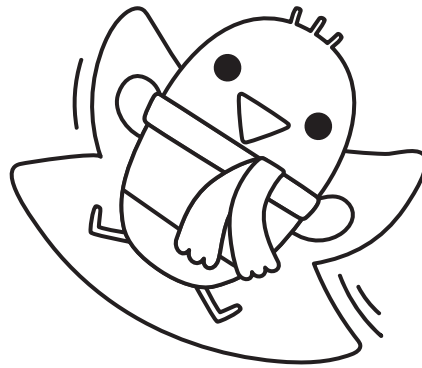

**Making a snow angel**



**Catching snowflakes**

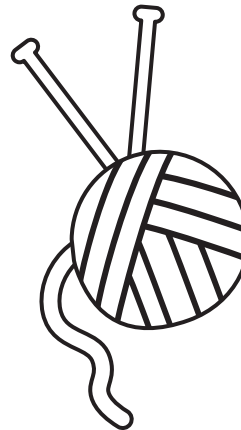

**Knitting**

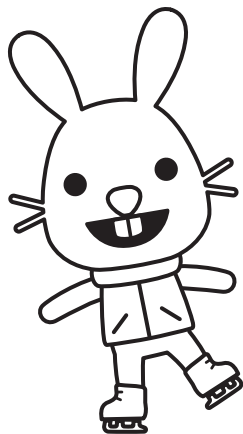

**Skating**

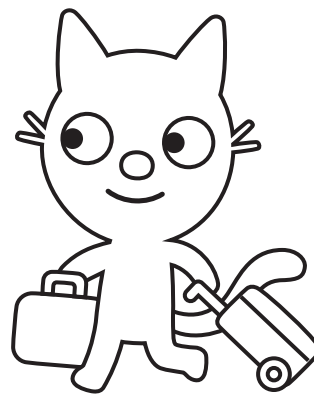

**Going on vacation**

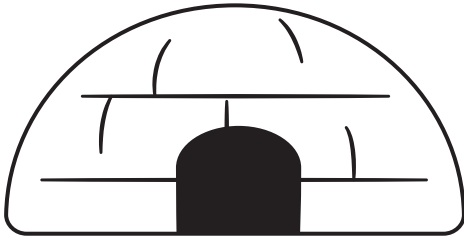

**Building an igloo**

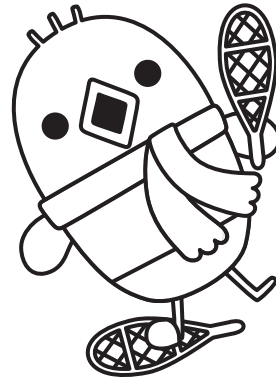

**Snowshoeing**

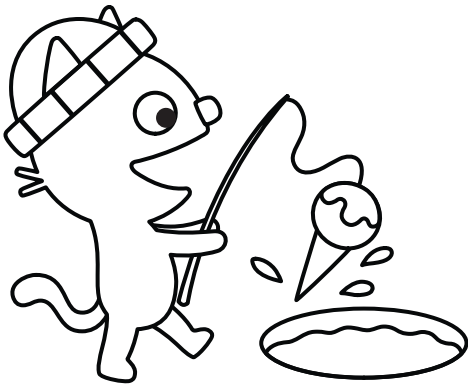

**Ice fishing**

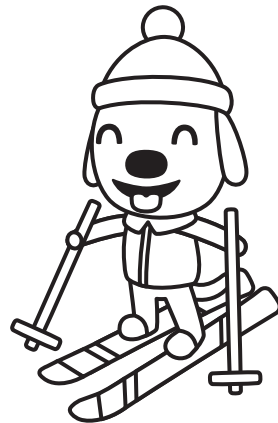

**Skiing**

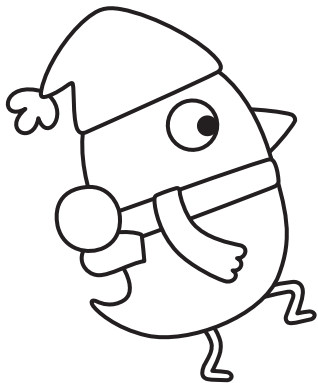

**Throwing a snowball**

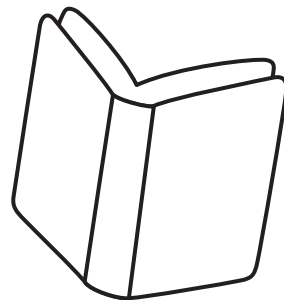

**Reading**

# Day 5: Neville's Sweater



## SAGO mini printables

### Instructions:

Print and color in the background and Neville. Decorate his sweater by gluing pompoms to it. Use the dotted circles as a guide for your pompoms – or go wild!

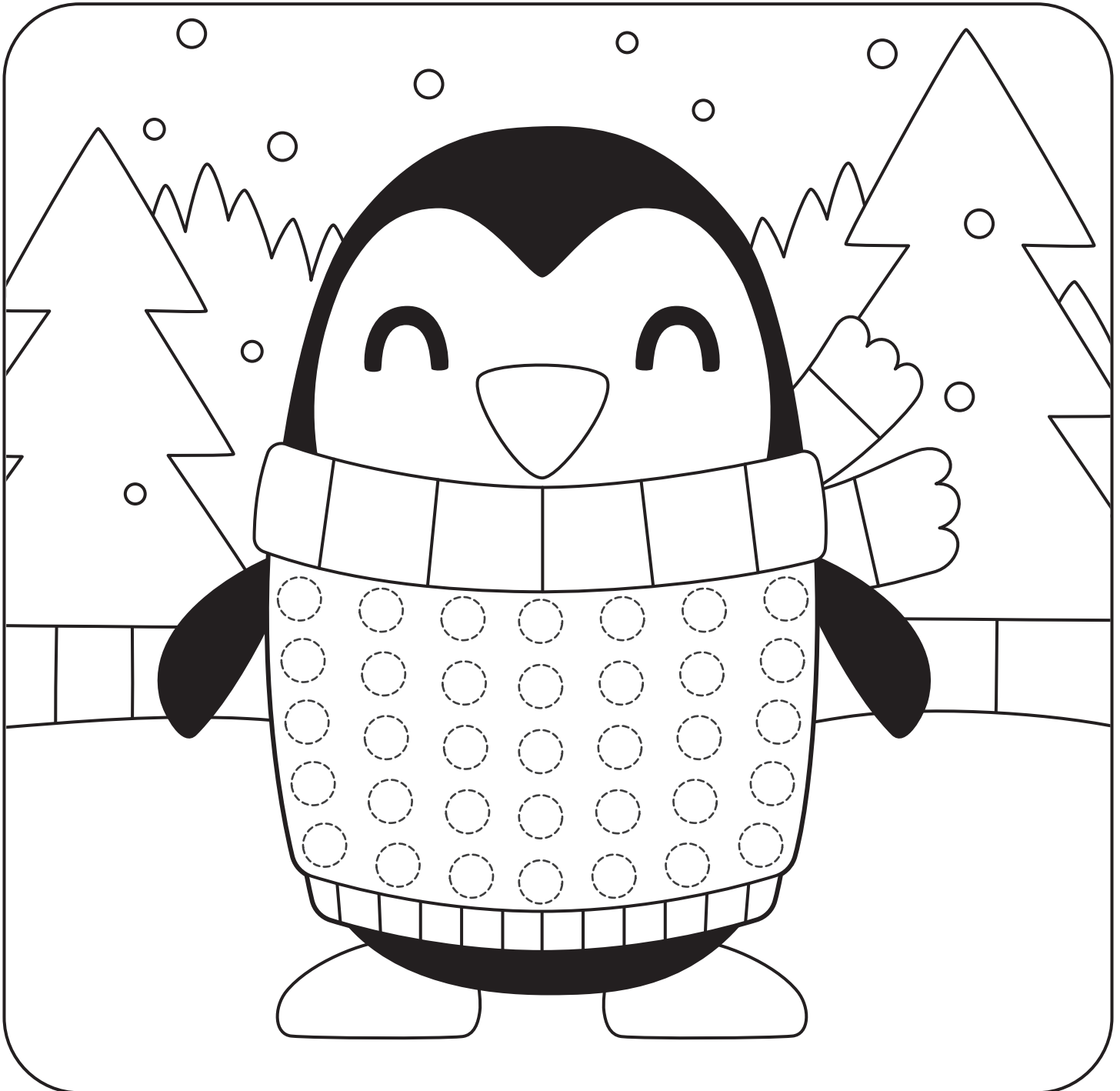



# Day 6: Snowflake Puzzle

**SAGO mini**  
**printables**

## Instructions:

Color and cut out the snowflake cards.  
Cut each snowflake in half. Mix them  
up, then find the matching pieces!

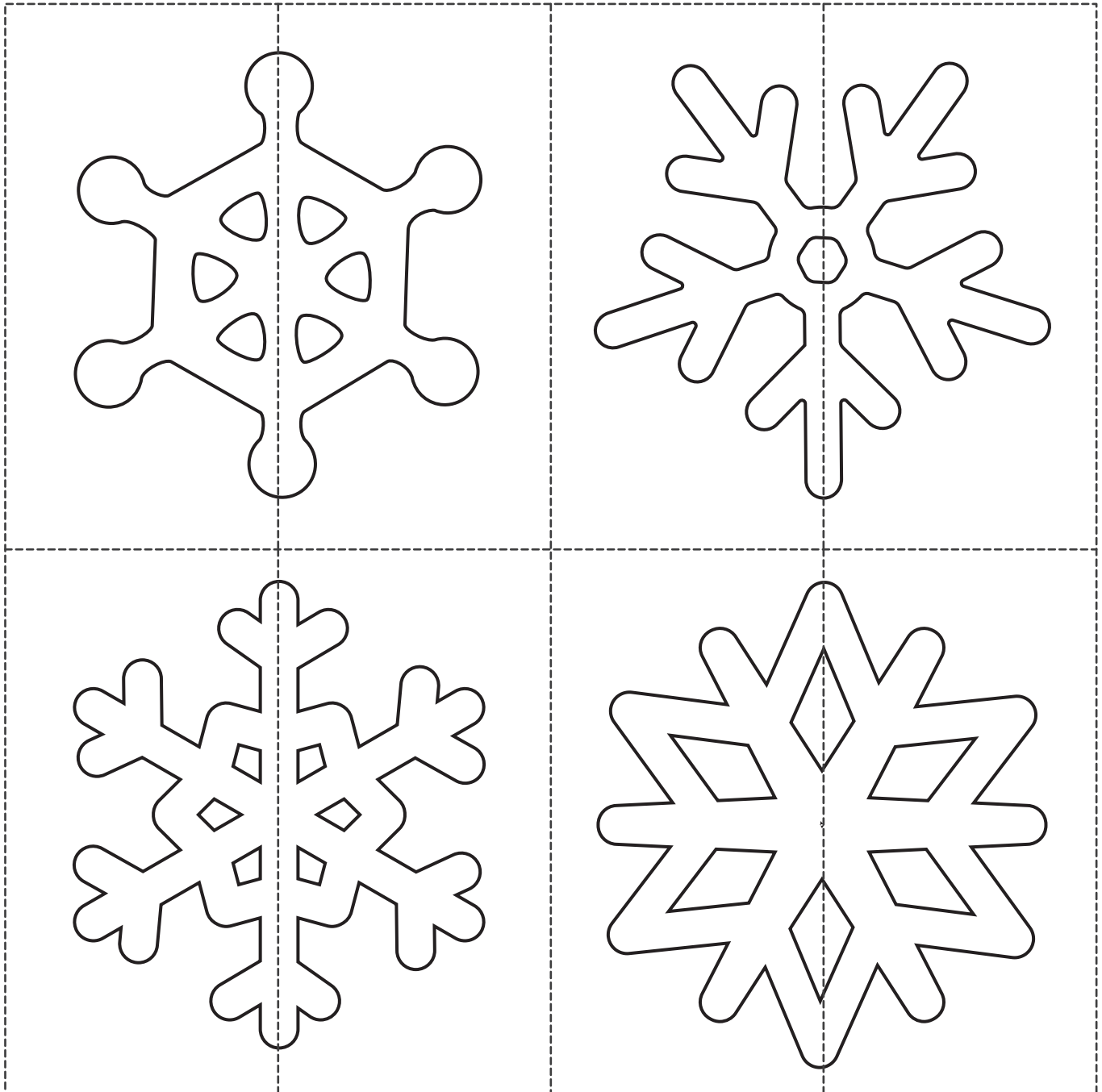

# SAGO mini printables

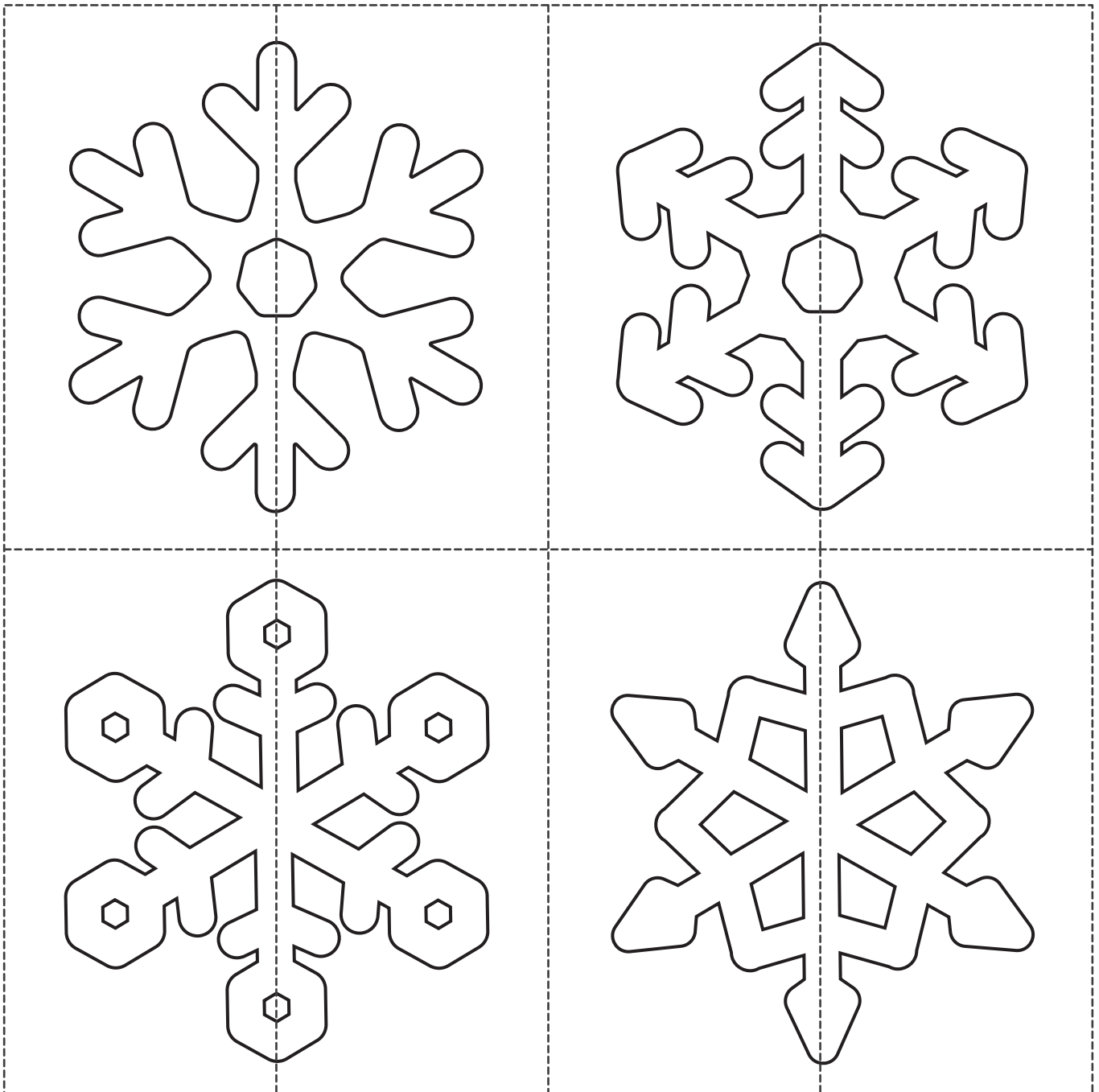

# Day 7: Vacation Dressup



**SAGO mini**  
**printables**

## Instructions:

Can you dress Harvey for a cold snowy day? How about a hot summer day? Color, cut, and combine your favorite outfits. Paste them on the winter or summer pictures.





**SAGO mini**  
**printables**

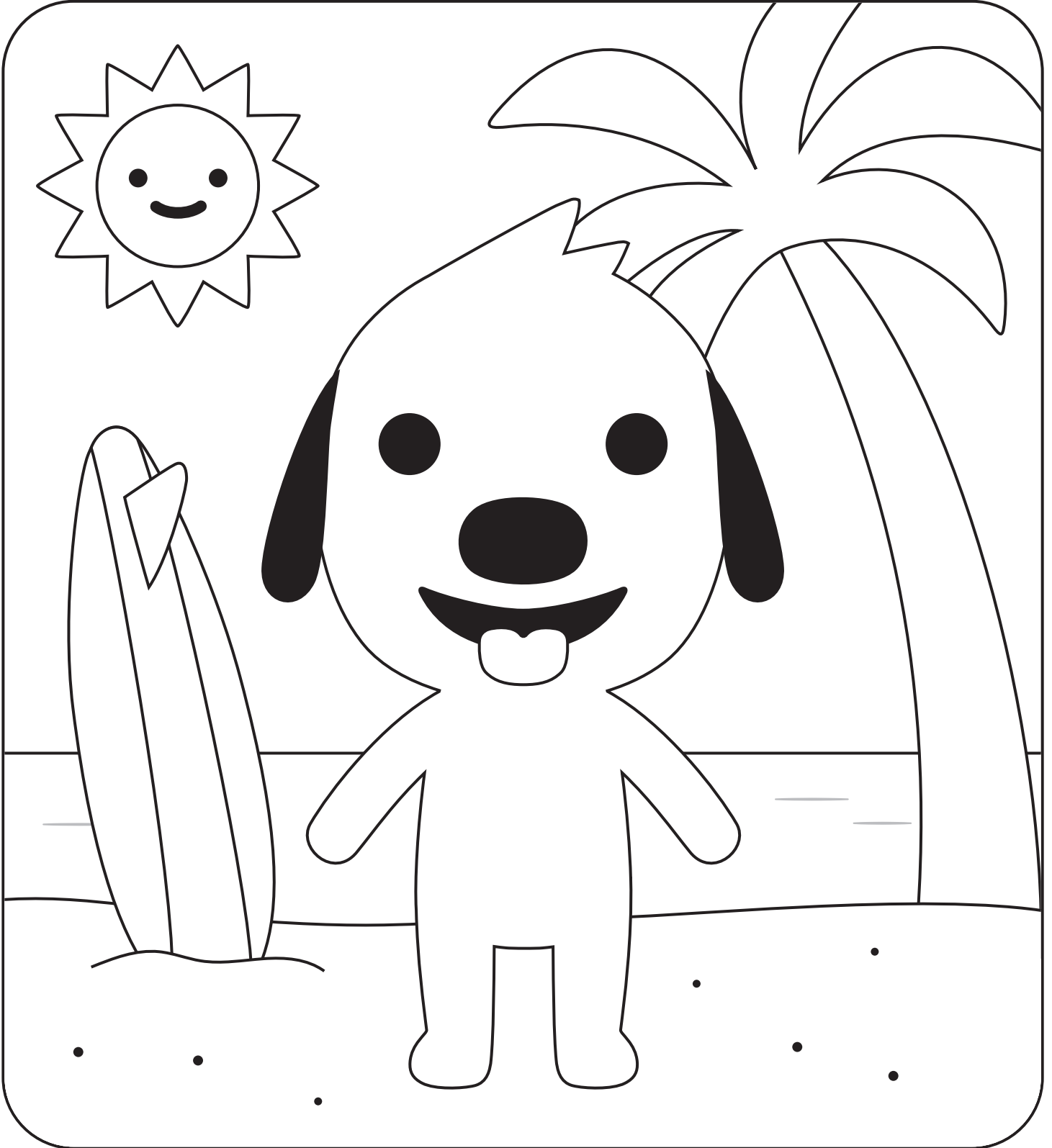

# SAGO mini printables

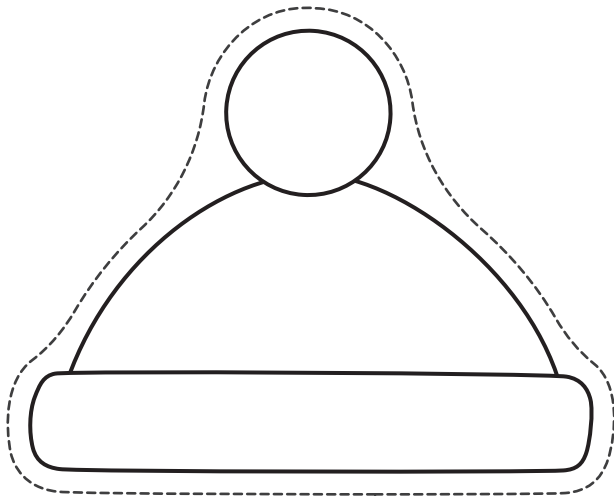

**BEANIE**

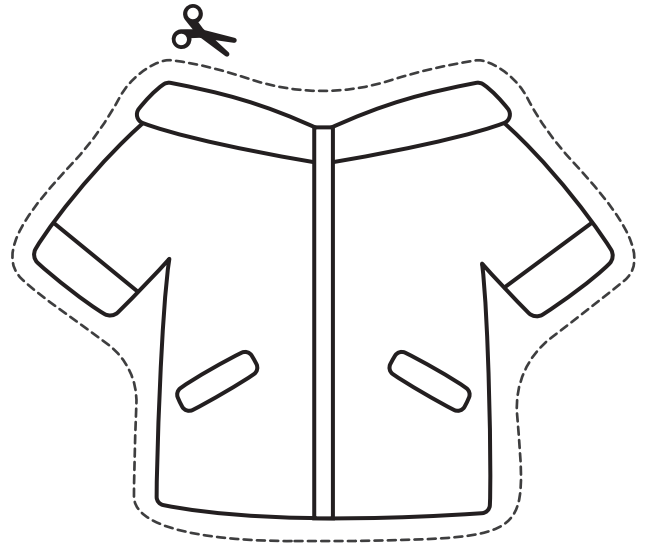

**COAT**

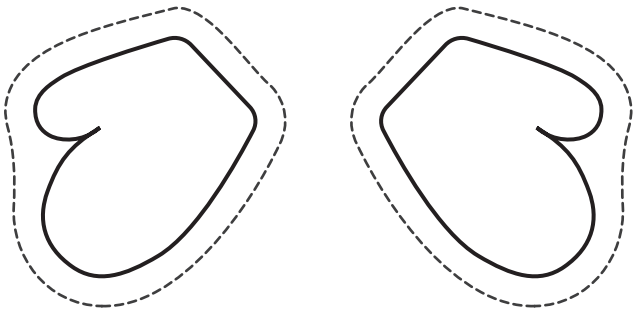

**MITTENS**

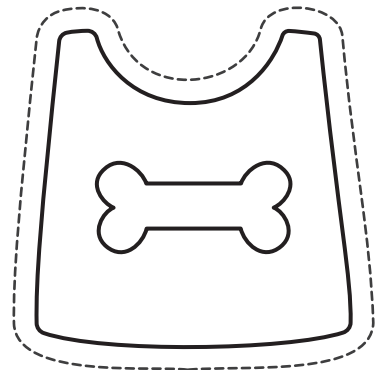

**TANK TOP**

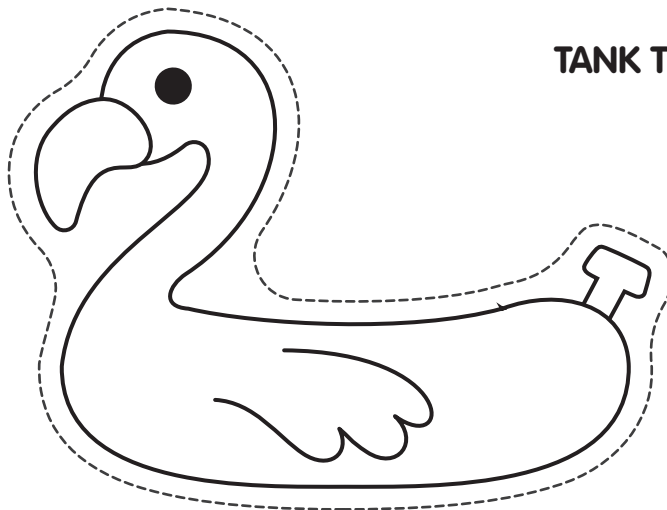

**FLOATIE**

# SAGO mini printables

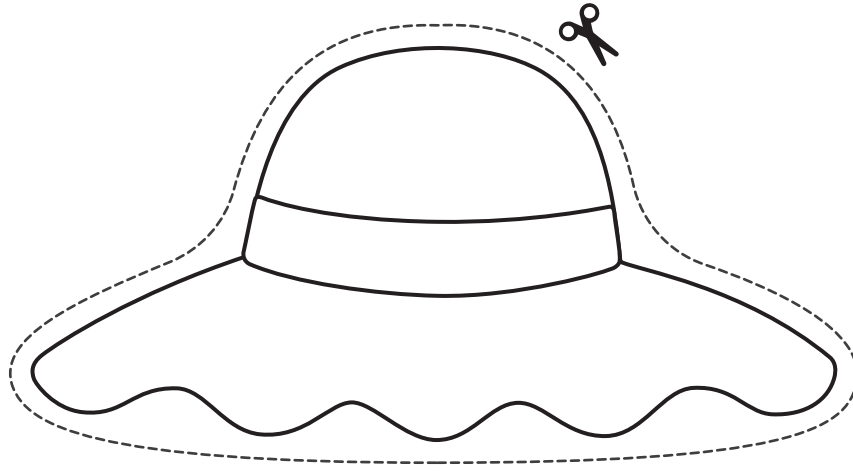

SUNHAT

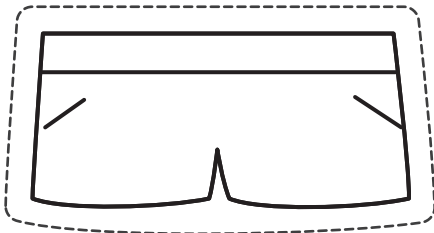

SHORTS



BOOTS

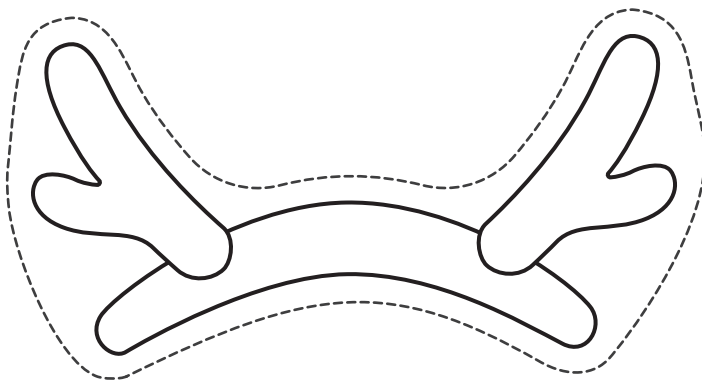

REINDEER ANTLERS

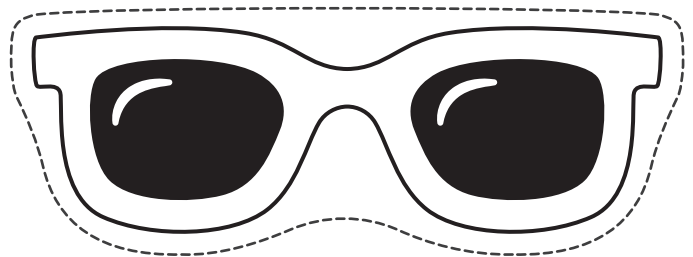

SUNGLASSES