

playground

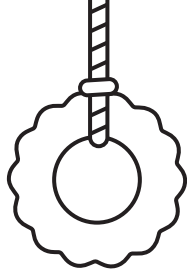

Did you know?

Playgrounds have been around since 1885!

Why did the chicken cross the playground?

To get to the other slide!

Quote:

"Play is the work of the child." - Maria Montessori

Activities included in this set:



Create, cut, and solve a puzzle.



Search for playground items in a scavenger hunt.

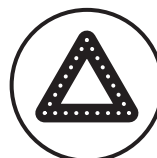

Trace shapes that are found on a playground.



Count the objects in a playground scene.



Supplies you'll need:



pencil



crayons



scissors



glue

SAGO mini
school



Download **Sago Mini School** on the iOS App Store for more learning games!

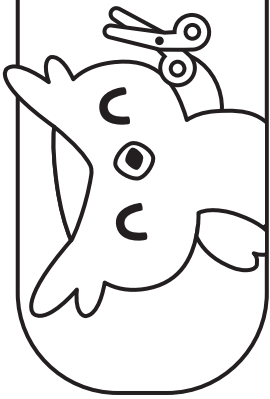

SAGOmini

school

Instructions:

Color and cut out the puzzle pieces,
mix them up then put the picture
back together!

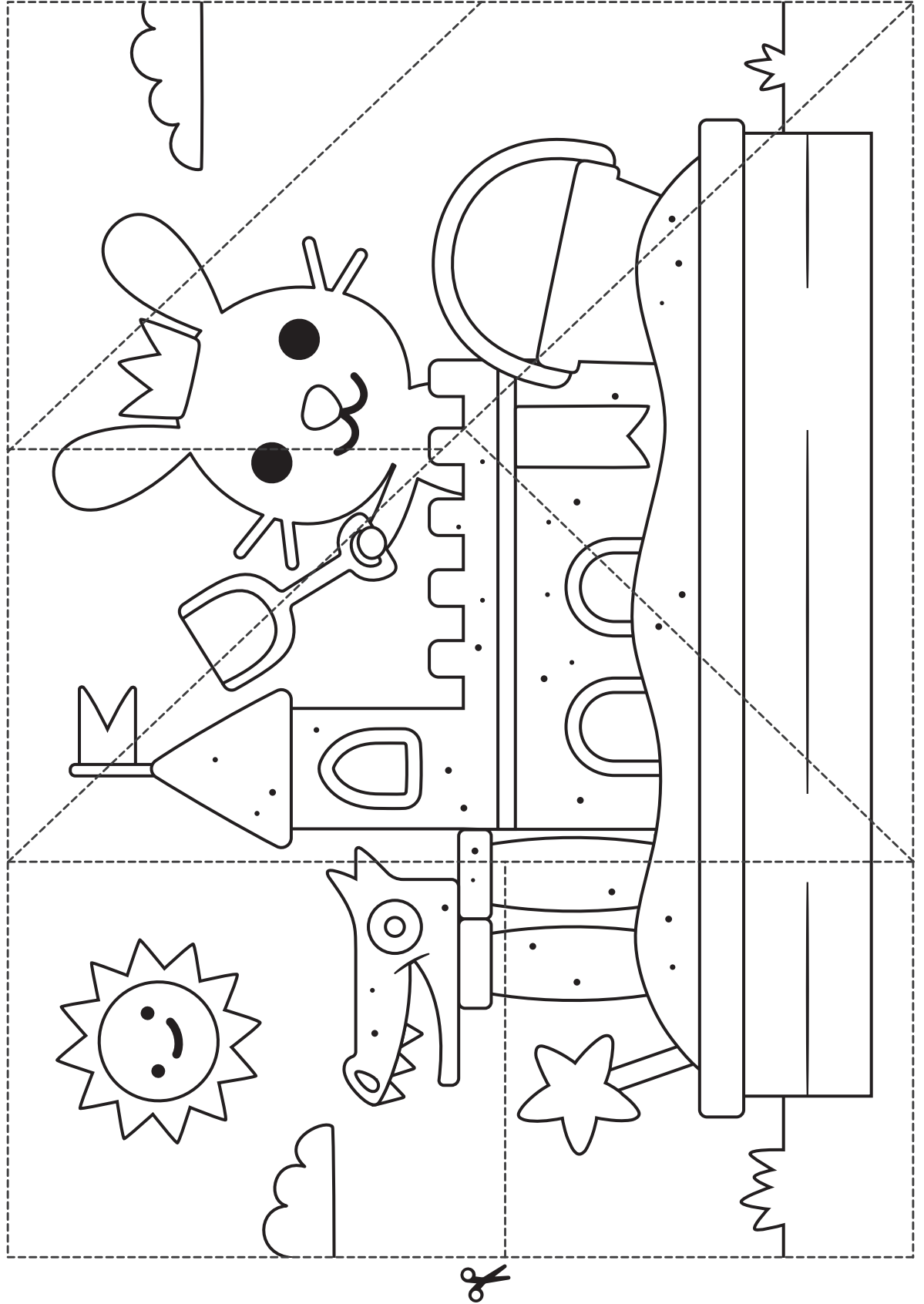

SAGOmini
school

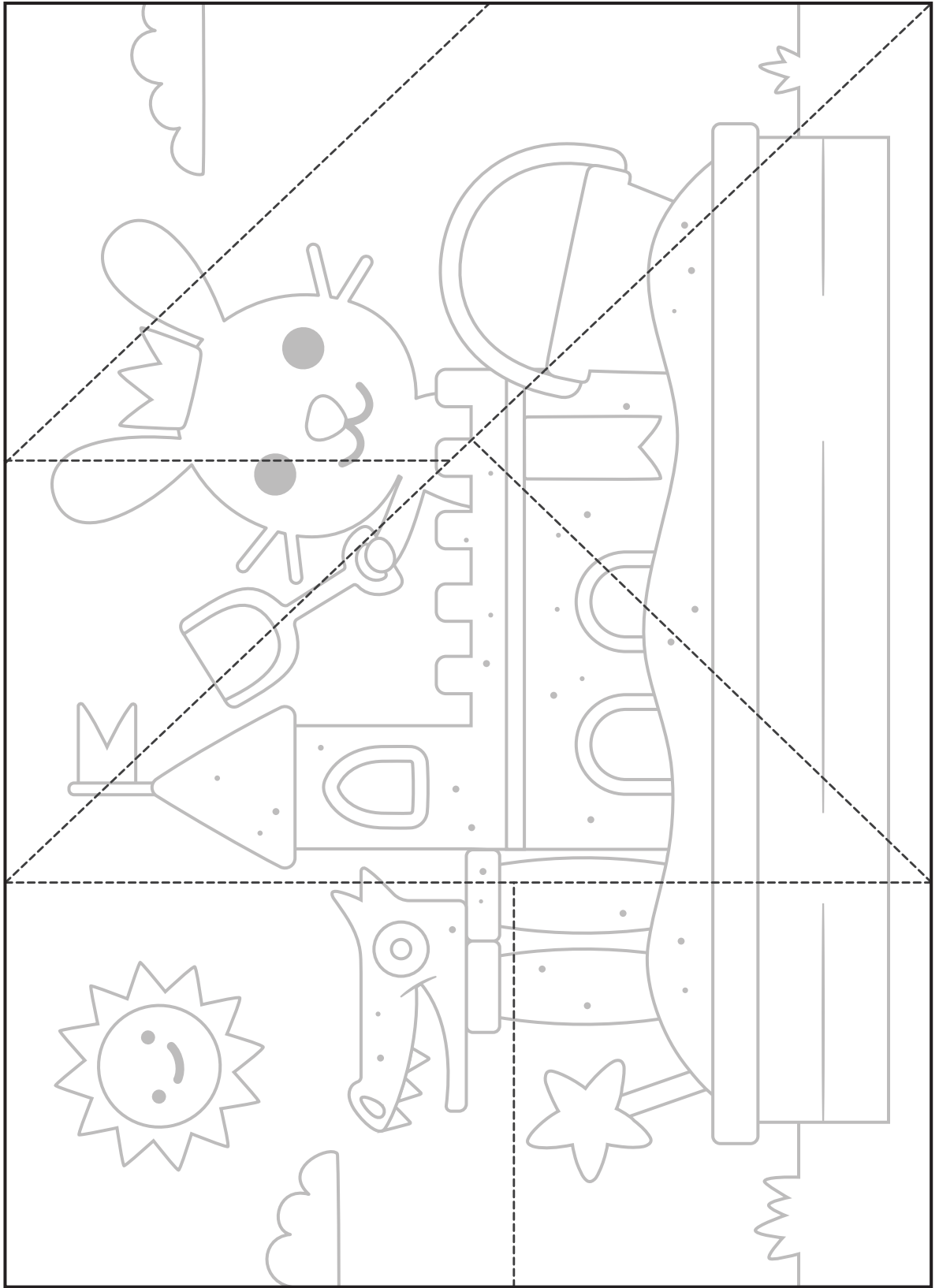

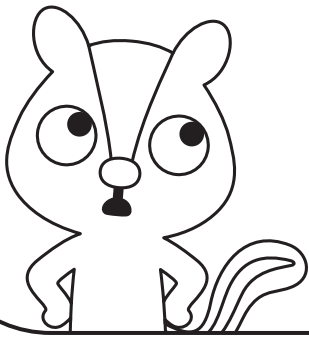





SAGO mini school

Instructions:



Try to find these items at your local playground. Color in the smiley face for each item you find, and write the total at the bottom. Next week, try a new playground!





LADDER

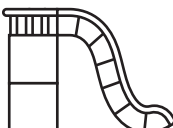



BRIDGE





SLIDE

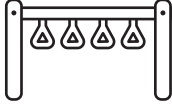



TUNNEL





MONKEY BARS





LEAF

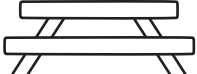



BALL

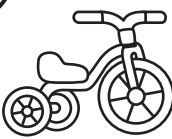



PICNIC TABLE





BICYCLE

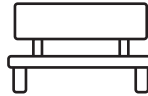



SANDBOX

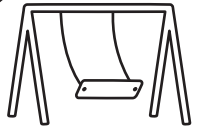



BENCH

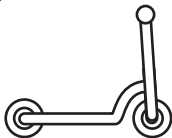



SWING





SCOOTER



SEESAW



PINE CONE



TREE

Total: _____

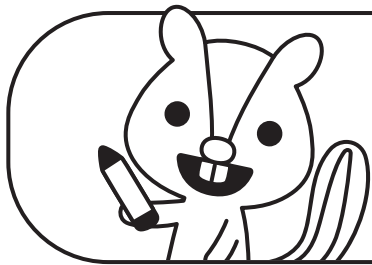

triangle

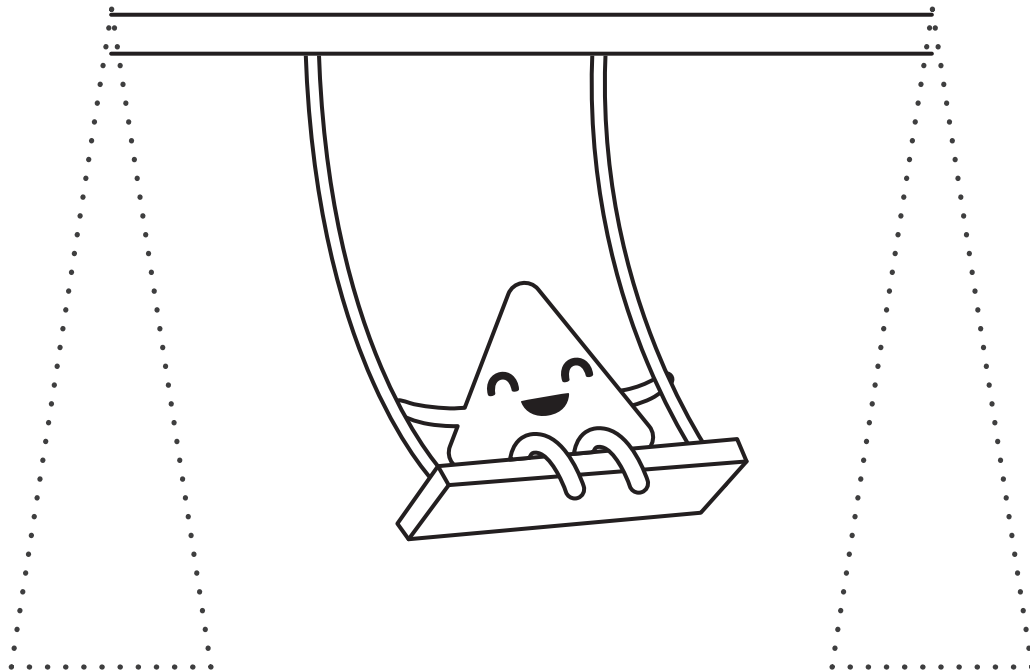
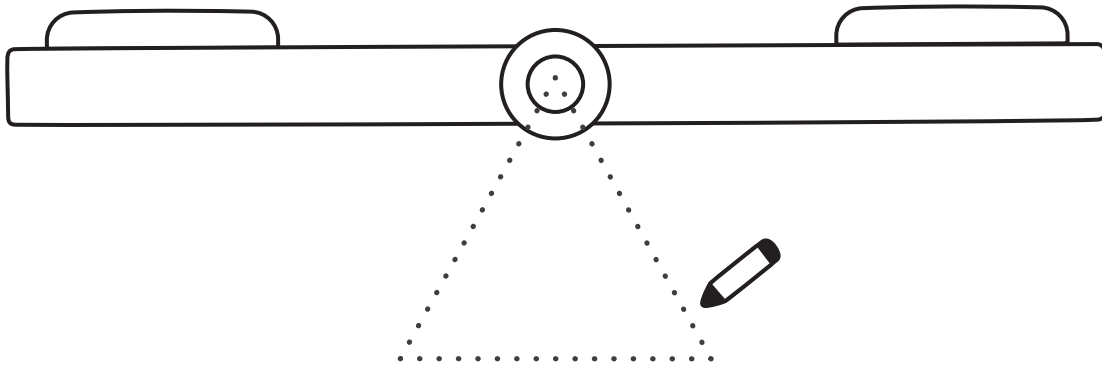

square

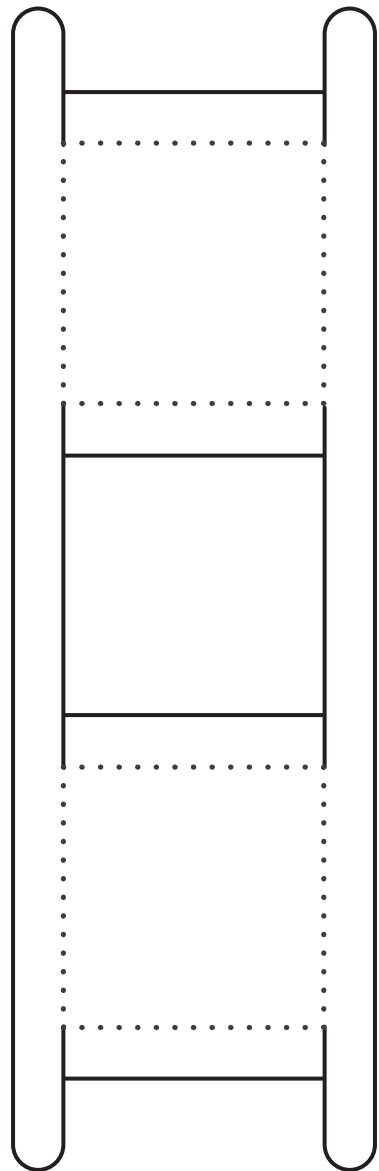
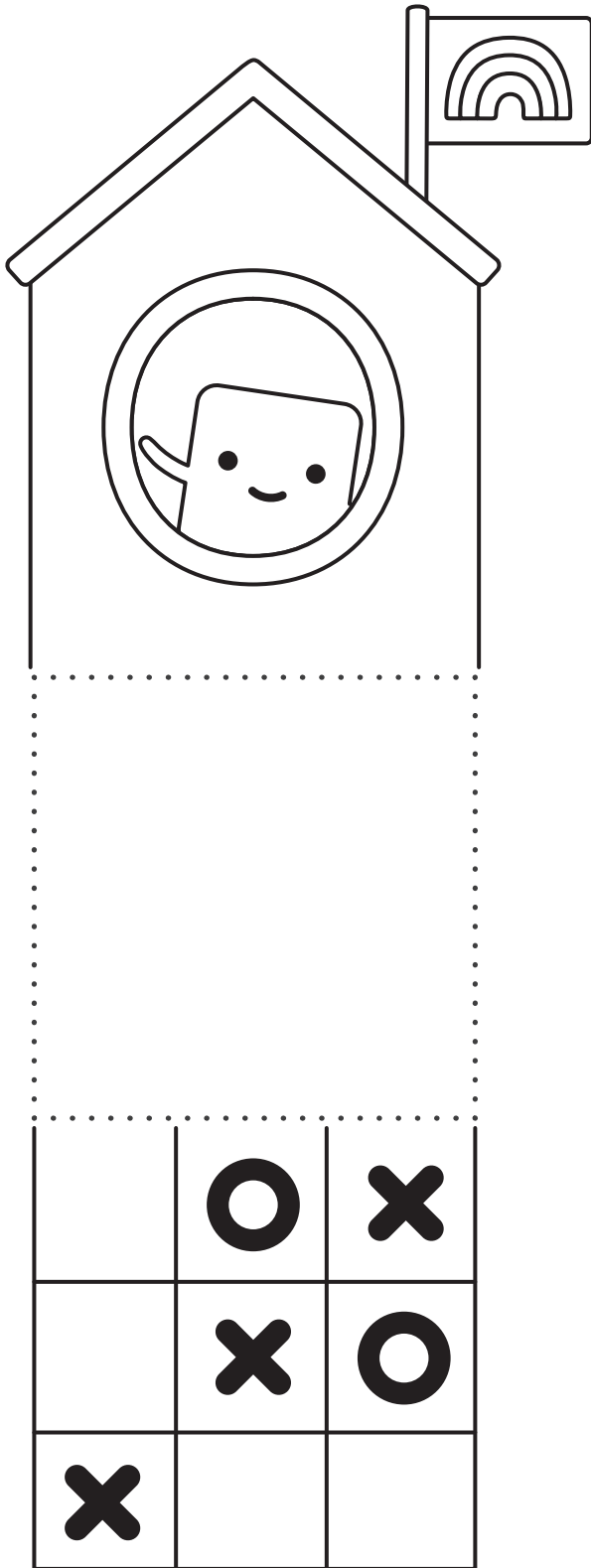

rectangle

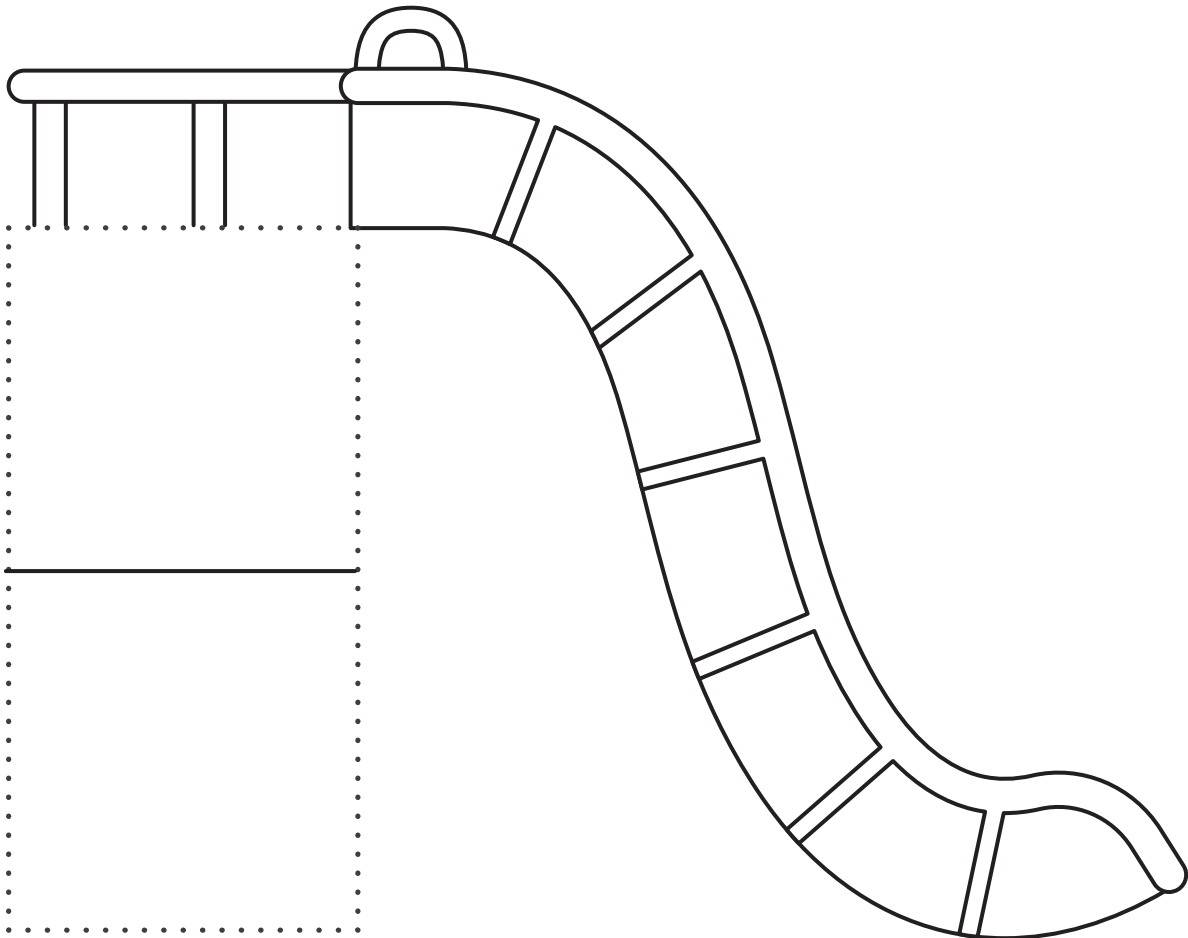
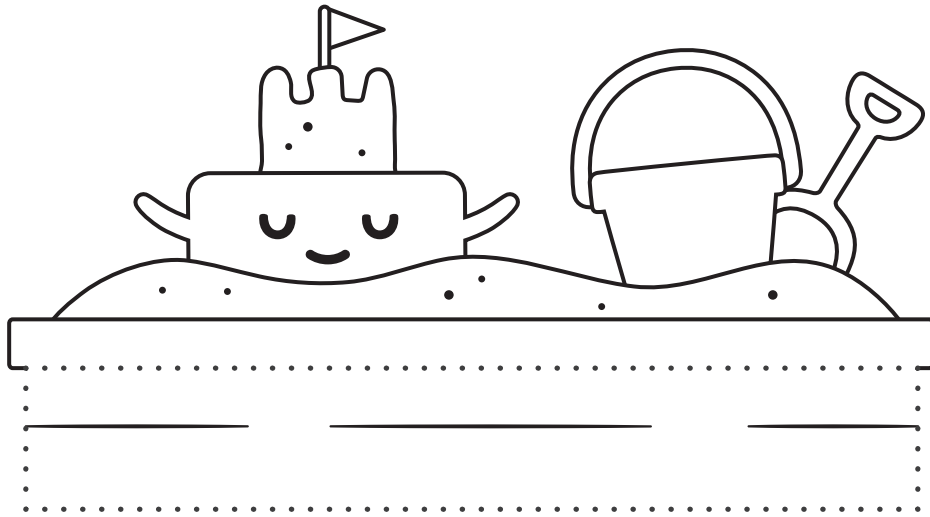

circle

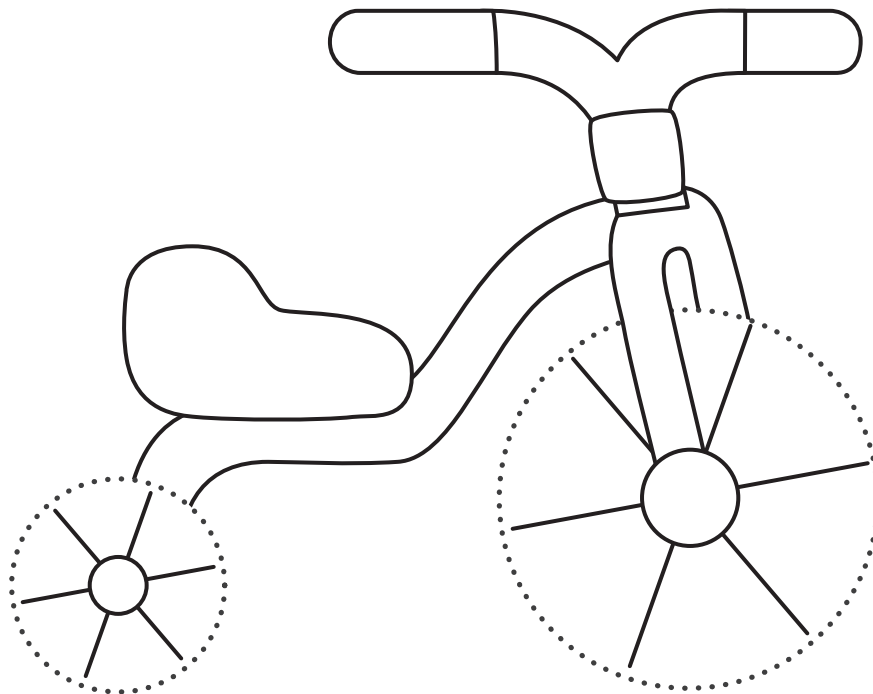
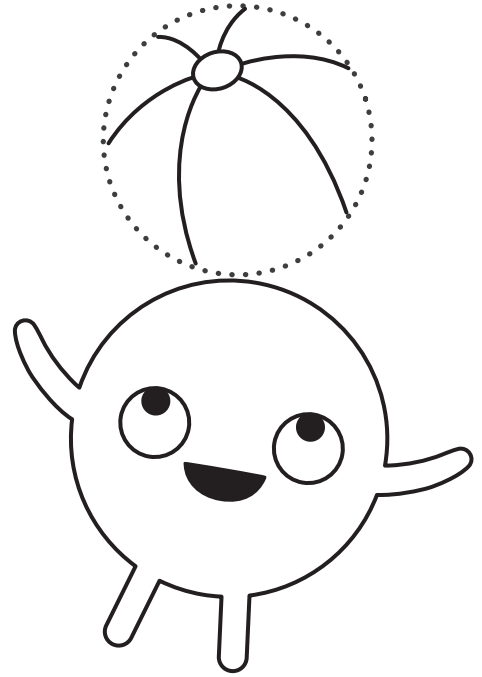
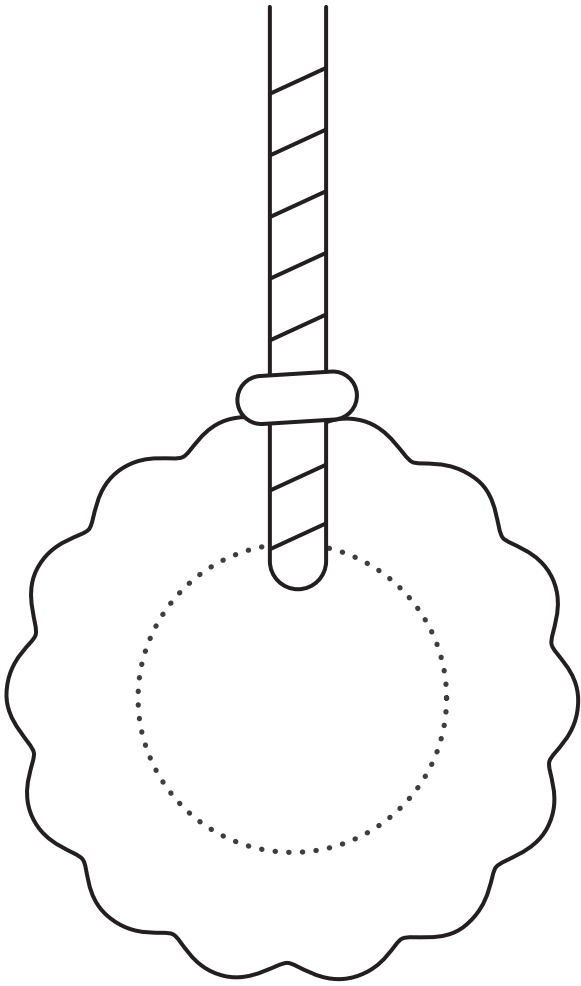

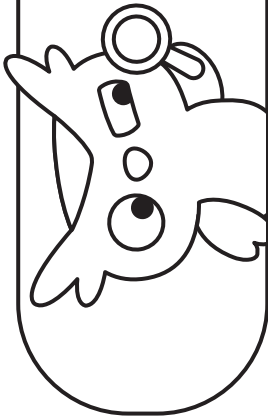







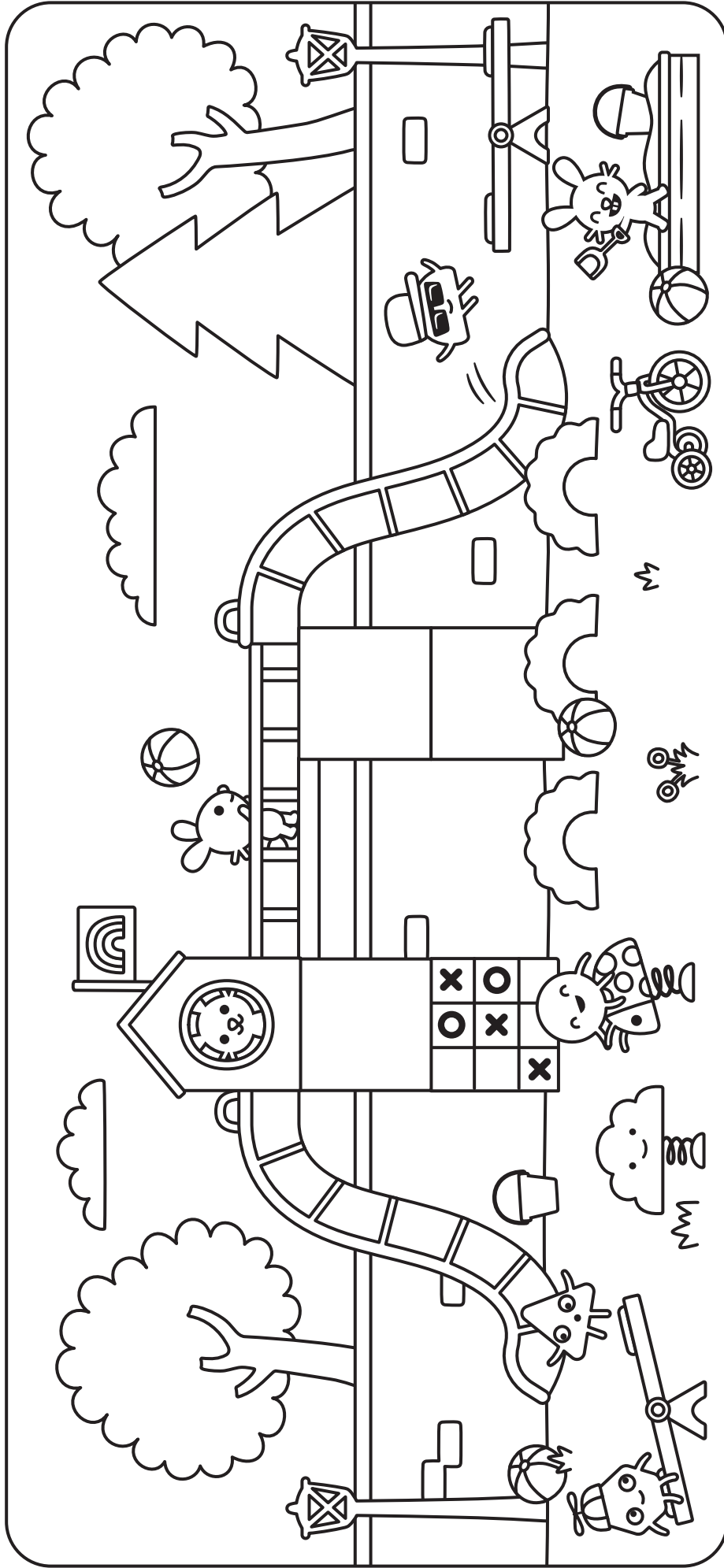

SAGO mini school

Instructions:

Find and count items in the playground scene, then write the number in each box.



- 
 SEE SAWS
- 
 TREES
- 
 TIRES
- 
 BALLS
- 
 SLIDES
- 
 BUCKETS
- 
 TRICYCLE